

REVISIONS

Zone	REV	ECN	DESCRIPTION	DATE	APPROVED
	**	2692761	NEW RELEASE	04/17/09	

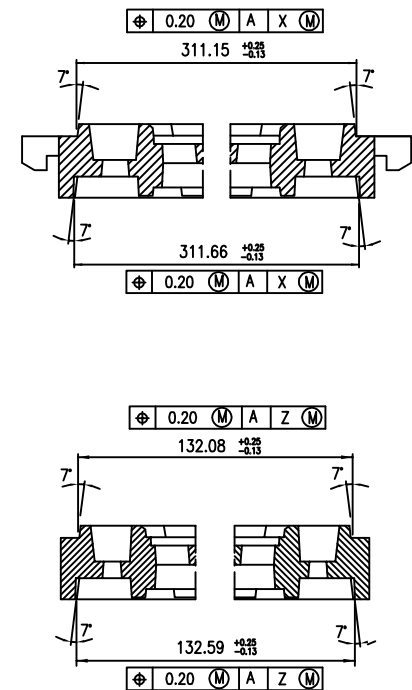
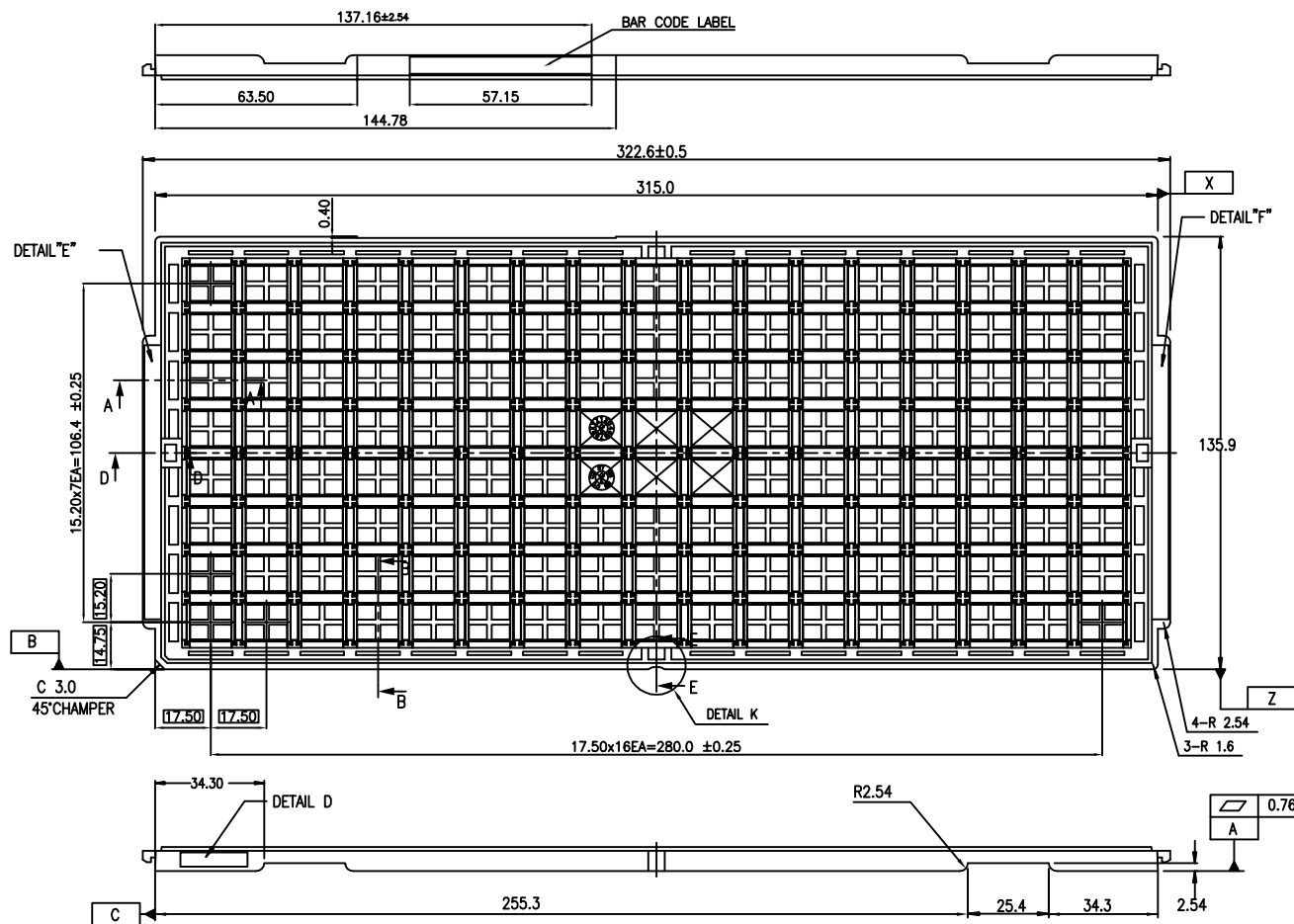

TRAY STACKING DETAIL  
(SCALE:4/1)

13mmx15mm FBGA 8x17  
KS - 88146 REV 01

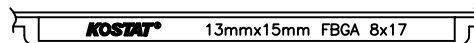

DETAIL E  
(SCALE:2/1)

DETAIL D  
(SCALE:2/1)

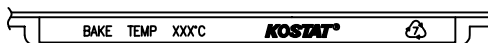

DETAIL F  
(SCALE:2/1)

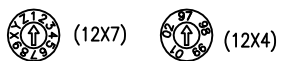

DATE DETAIL  
(SCALE:2/1)

UNLESS OTHERWISE SPECIFIED		DESIGNED BY	DATE	CYPRESS Company Confidential	
ALL DIMENSIONS ARE IN MILLIMETERS STANDARD TOLERANCES ON		DRAWN BY	DATE		
DECIMALS	ANGLES	AZY	04/17/09		
X.X = ± 0.25	± 1°	CHK BY	DATE		
X.XX = ± 0.13		CNN	04/17/09		
X.XXX = ± 0.05		APPROVED BY	DATE		
MATERIAL		APPROVED BY	DATE		
N/A					
FINISH					
N/A					
TITLE		SIZE	PART NO.	DWG NO.	REV
TRAY, FBGA 15X13 MM (KOSTAT)		A	TBB15131.4J-*	001-52948	**
SCALE		NTS		SHEET 1 OF 2	

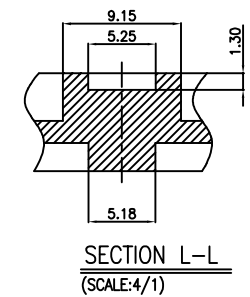
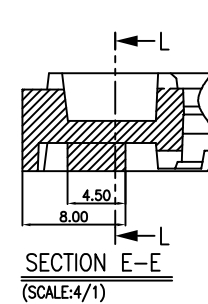
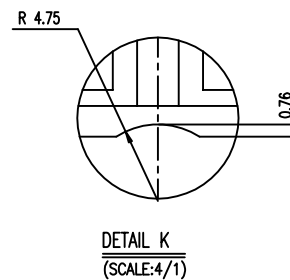
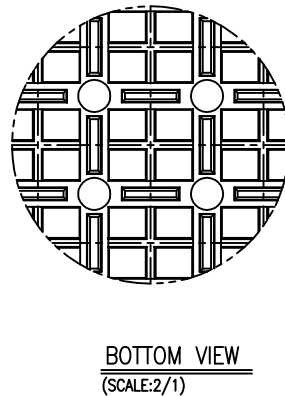
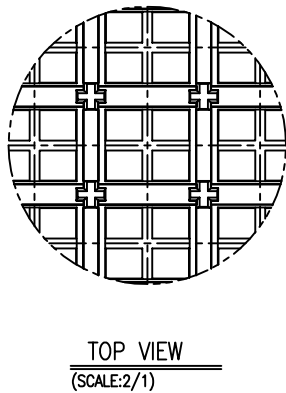
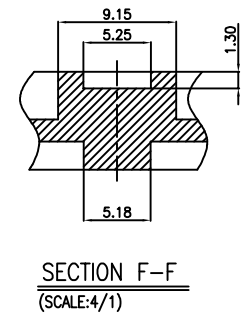
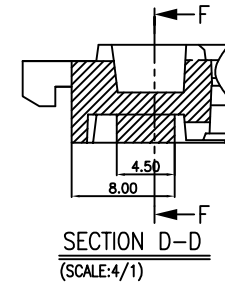
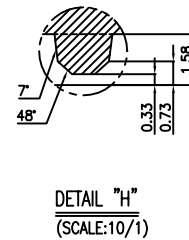
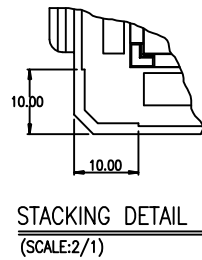
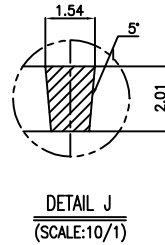
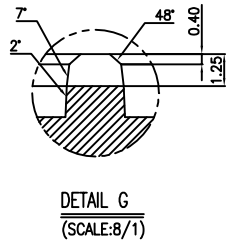
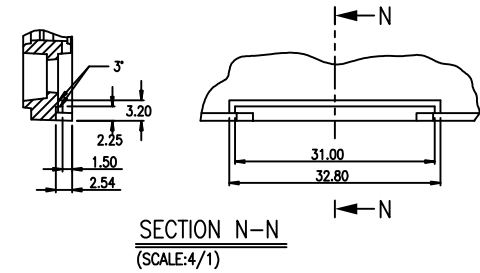
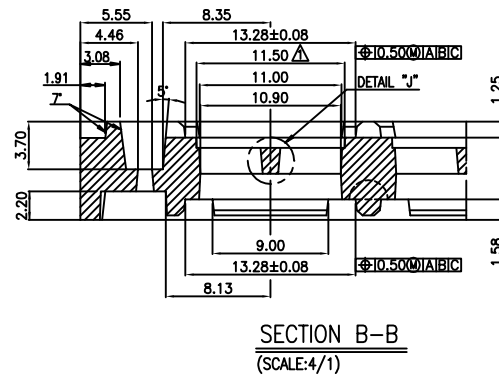
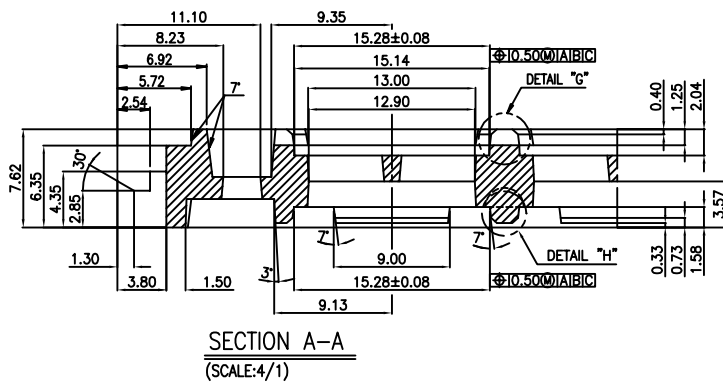

UNLESS OTHERWISE SPECIFIED ALL DIMENSIONS ARE IN MILLIMETERS STANDARD TOLERANCES IN DECIMALS X.X = ± 0.25 X.XX = ± 0.13 X.XXX = ± 0.075 ANGLES ± 1°	DESIGNED BY	DATE	<b>CYPRESS</b> Company Confidential						
	DRAWN BY	DATE				TITLE			
	CHK BY	DATE				SIZE	PART NO.	DWG NO.	REV
	APPROVED BY	DATE				A	TBB15131.4J-*	001-52948	**
	MATERIAL	DATE				SCALE	NTS	SHEET 2 OF 2	
FINISH	N/A								