

Revision History

Version	Date	Updated by	Approved by	Modifications
1.0.0	2013-05-02	Rex Cao		First draft
1.1.0	2013-06-17	Kevin Lin		1. D2->LED3,D3->LED4,D6->LED5 2. CN3 (J6 of V1.0.0) P5-->GND,CN4 (J14 of V1.0.0) P5-->GND 3. TPOINT GND->TPOIN VSS 4. All of the J? has renamed, and add J19,J20 5. R11 510R->10K 6. R9 10M->1M 7. Q1,Q2 package update 8. SDRAM CS change from MCSX1_0 (PIN96) to MCSX8_0 (PIN35) 9. Add R13, R14 for Oscillator of MB9BF568R (U1)
1.2.0	2014-03-24	Rex Cao		1. Update the Title Bar to Spansion Inc.
1.3.0	2014-09-03	Rex Cao		1. Change the SDRAM to HY57V281620FTP-H.

Spansion Inc.		
Author: Rex.Cao		
Title		
(SCH)SK-FM4-U120-9B560(-MEM)		
Size	Document Number	Rev
A4	Cover	V1.3.0
Date: Wednesday, September 03, 2014		Sheet 1 of 9

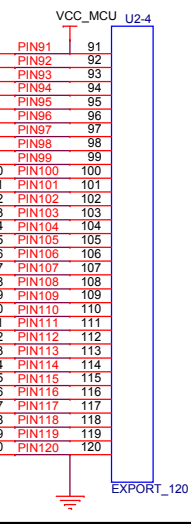

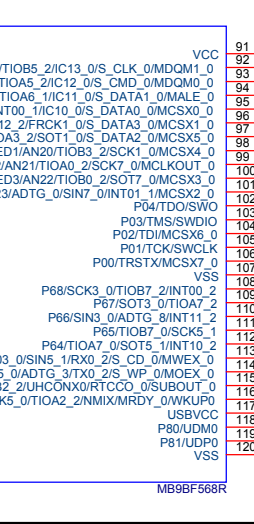
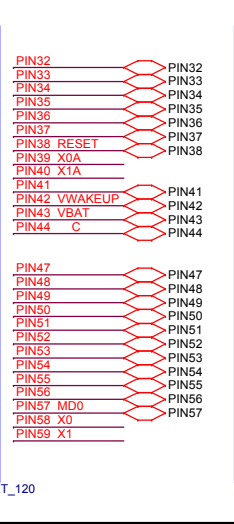
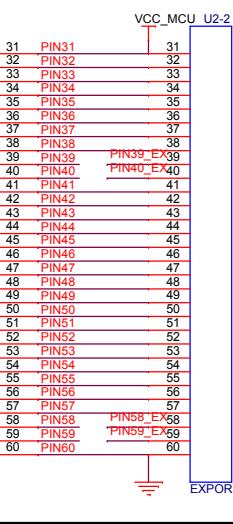
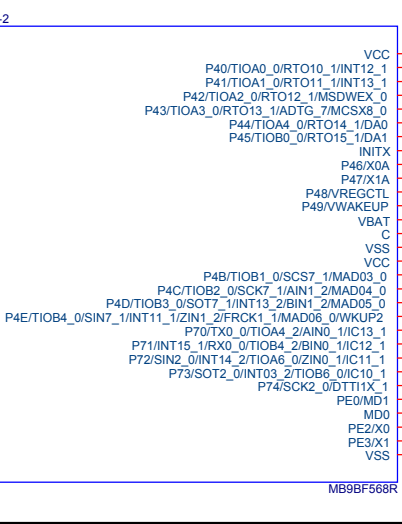
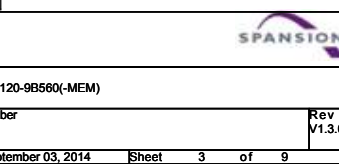
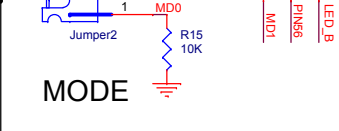
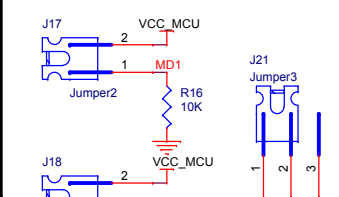
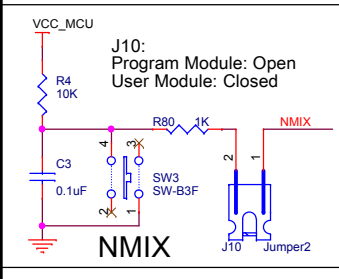
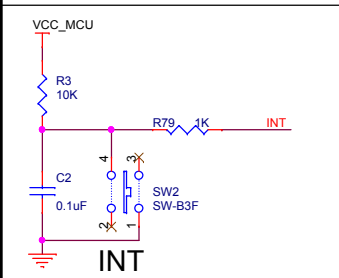
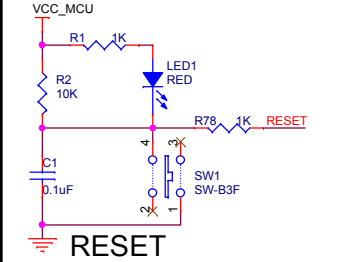
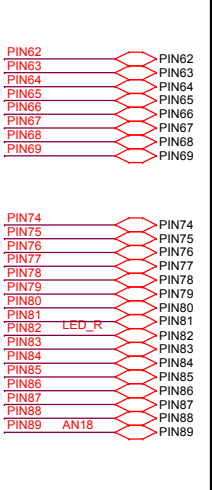
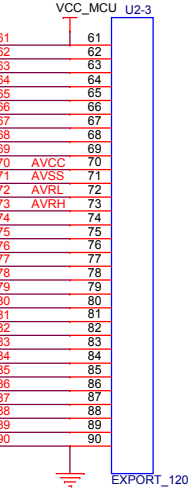
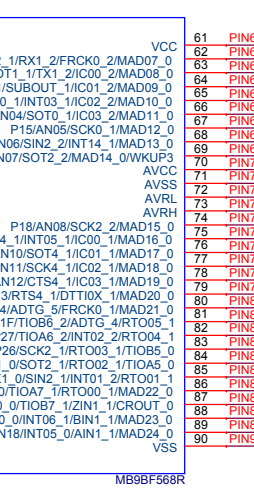
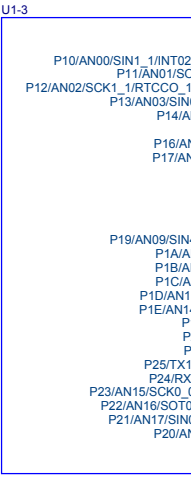
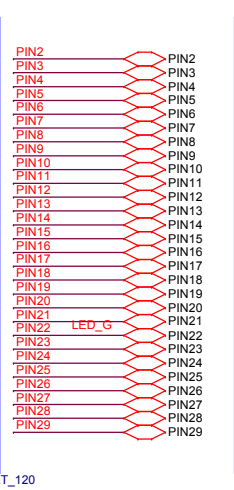
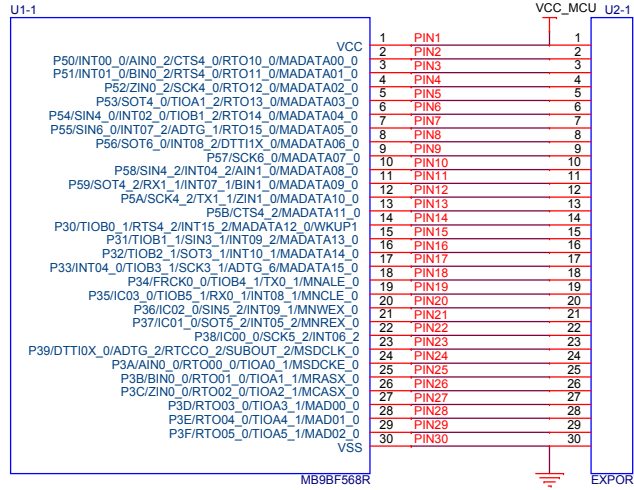

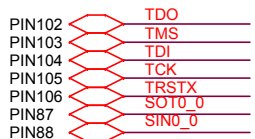

J3:
JTAG Module: CLOSED
DAP Module: OPEN

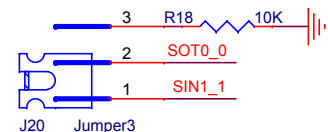
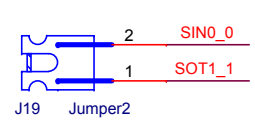
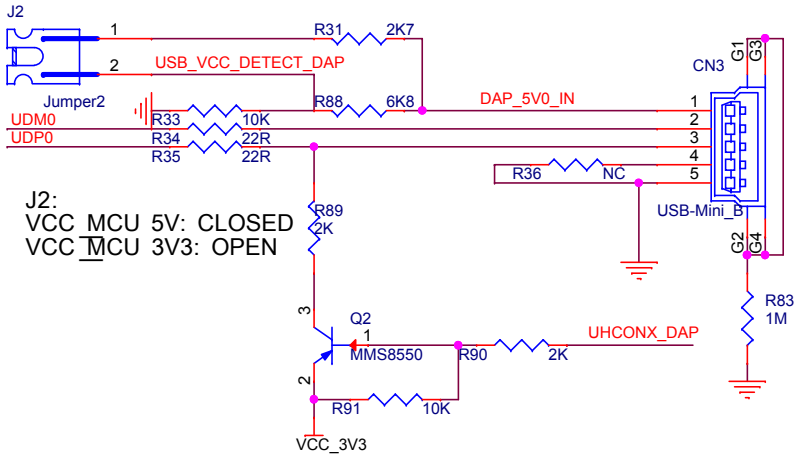
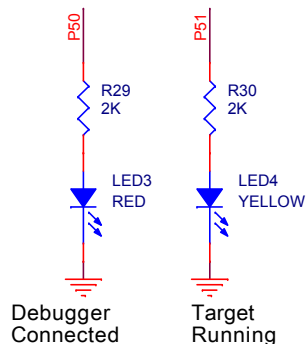
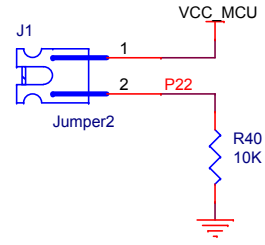
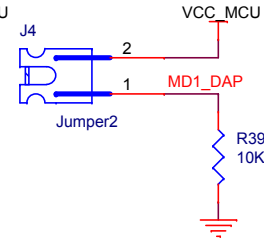
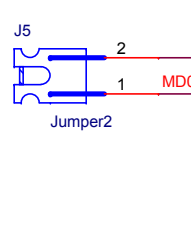
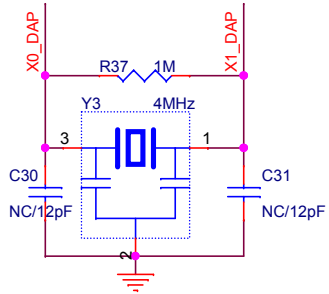
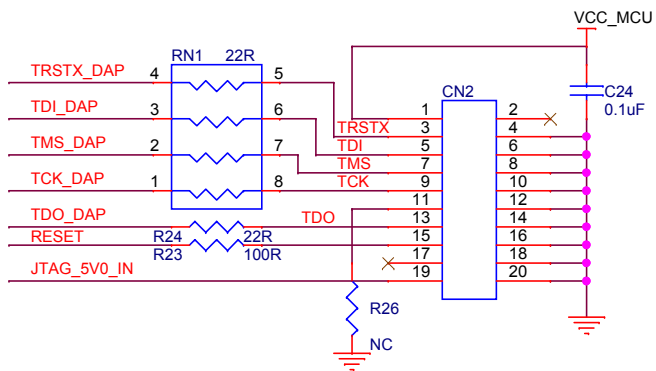
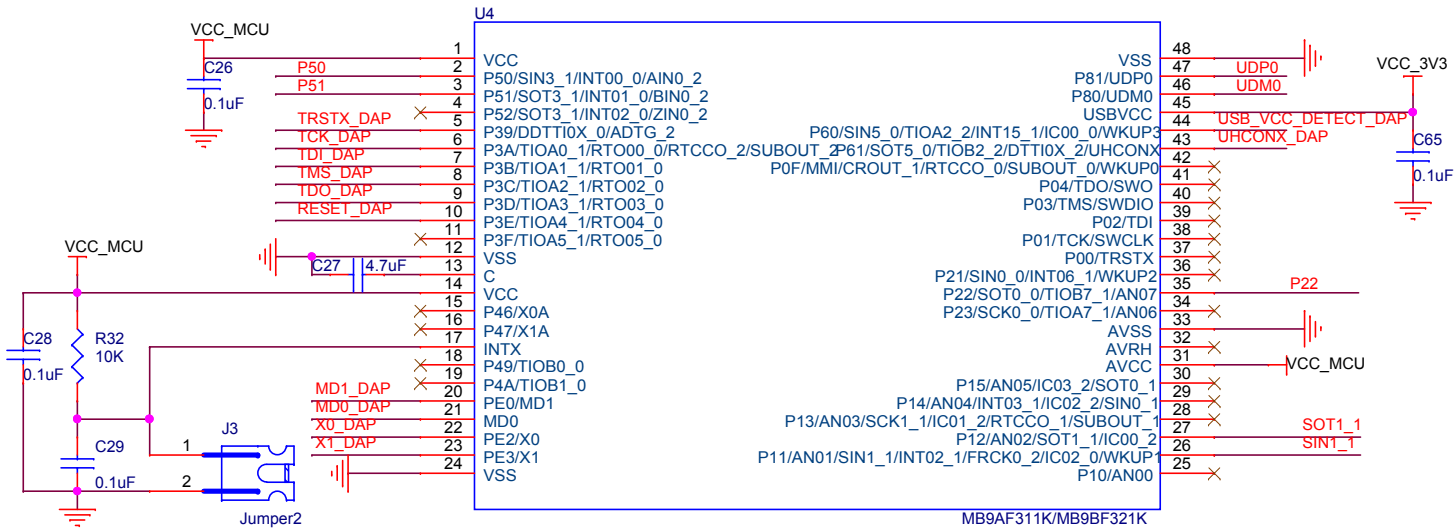

J2:
VCC MCU 5V: CLOSED
VCC MCU 3V3: OPEN

Spanسیون Inc.
Author: Rex.Cao

Title: (SCH)SK-FM4-U120-9B560(-MEM)

Size A4	Document Number JTAG	Rev V1.3.0
---------	----------------------	------------

Date: Wednesday, September 03, 2014 Sheet 4 of 9

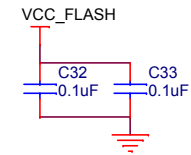
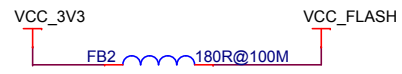
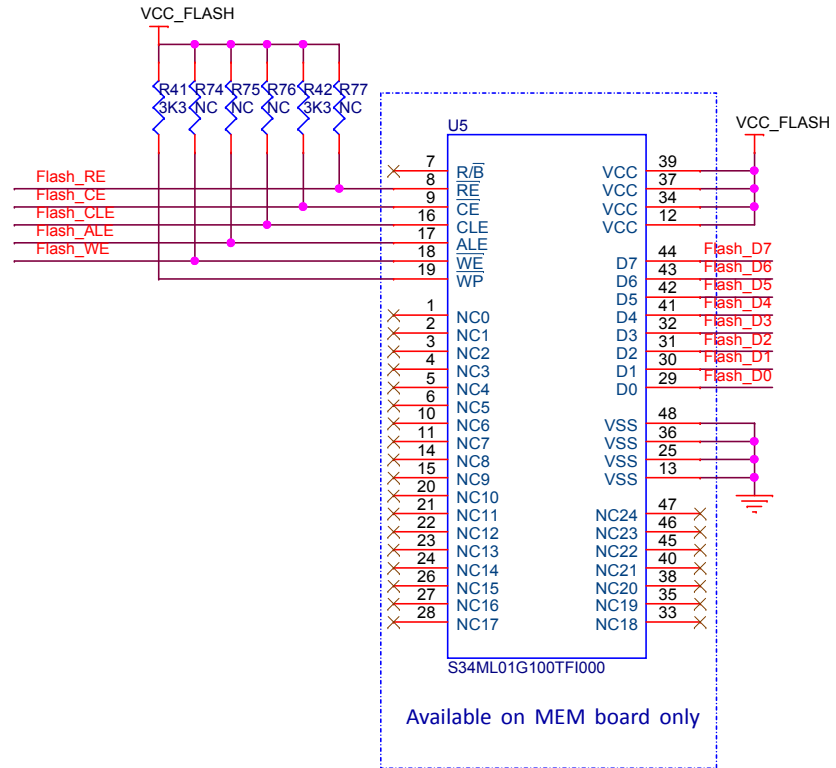
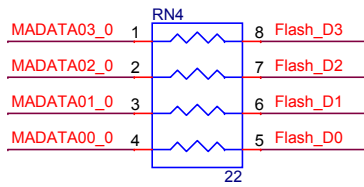
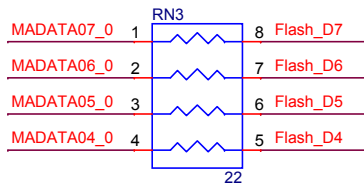
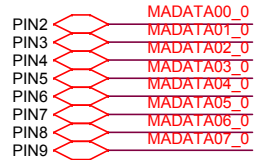
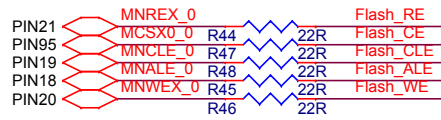

Spanسیون Inc.
 Author: Rex.Cao

Title
 (SCH)SK-FM4-U120-9B560(-MEM)

Size A4	Document Number NAND FLASH	Rev V1.3.0
------------	-------------------------------	---------------

Date: Wednesday, September 03, 2014 Sheet 5 of 9

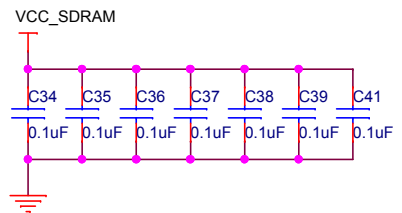
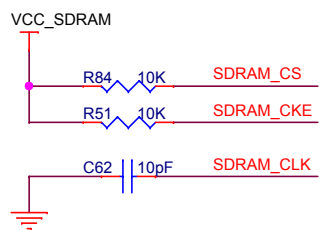
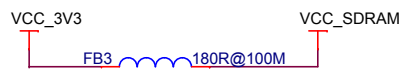
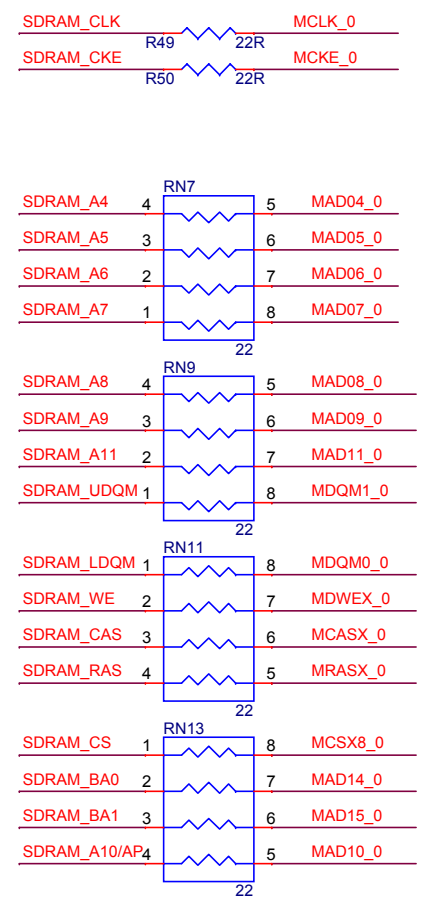
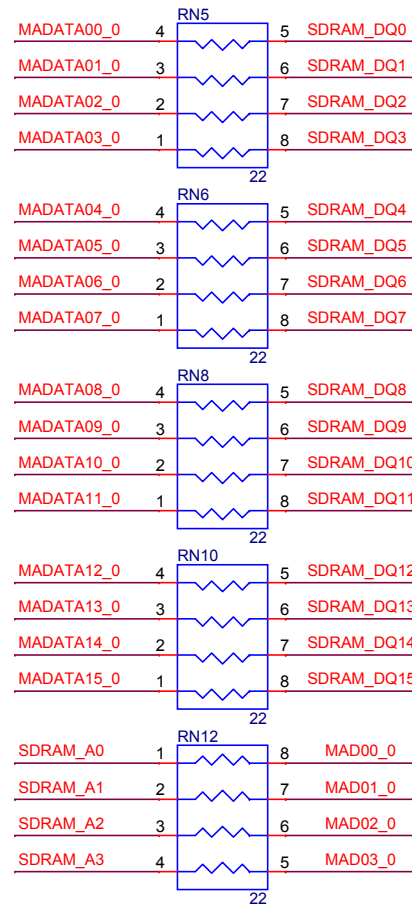
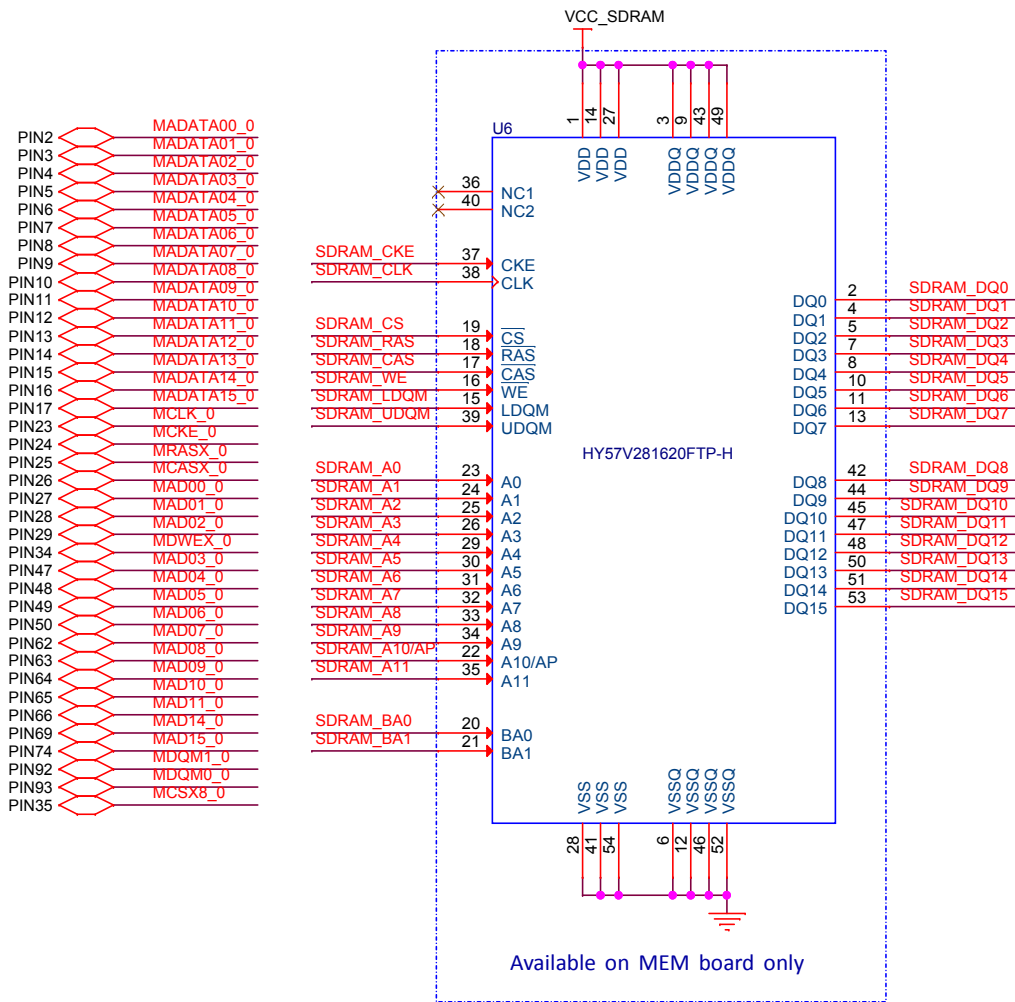

Spansion Inc.
 Author: Rex.Cao

Title
 (SCH)SK-FM4-U120-9B560(-MEM)

Size A4	Document Number SDRAM	Rev V1.3.0
------------	--------------------------	---------------

Date: Wednesday, September 03, 2014 Sheet 6 of 9

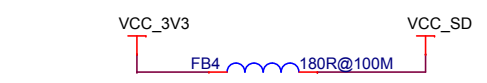
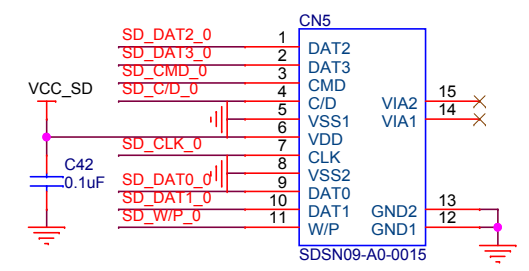
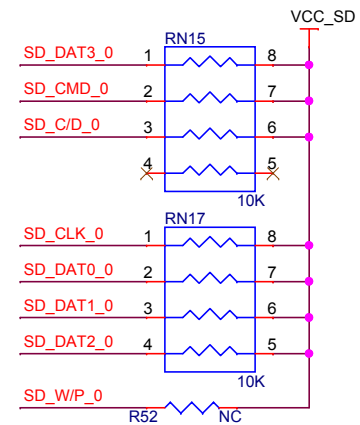
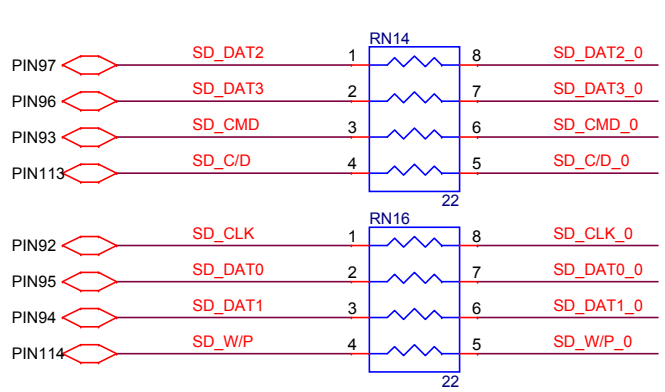

SpanSION Inc.
 Author: Rex.Cao
 Title: (SCH)SK-FM4-U120-9B560(-MEM)
 Size: A4 | Document Number: Micro SD | Rev: V1.3.0
 Date: Wednesday, September 03, 2014 | Sheet: 7 of 9



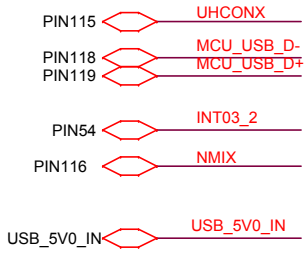

J13:
 VCC MCU 5V: CLOSED
 VCC MCU 3V3: OPEN

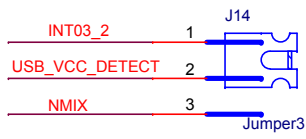
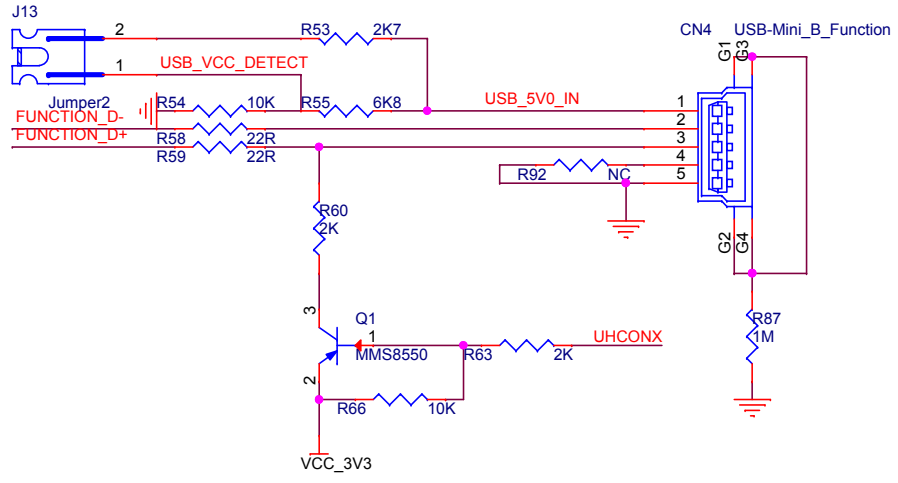

J14:
 Program Module: Closed Pin2 to Pin3
 User Module: Closed Pin2 to Pin1

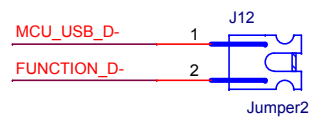

J11, J12:
 Function: CLOSED
 Host: OPEN

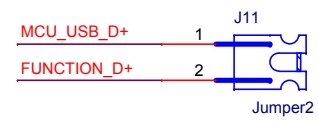

Spansion Inc.		
Author: Rex.Cao		
Title		
(SCH)SK-FM4-U120-9B560(-MEM)		
Size	Document Number	Rev
A4	USB	V1.3.0
Date: Wednesday, September 03, 2014		Sheet 8 of 9

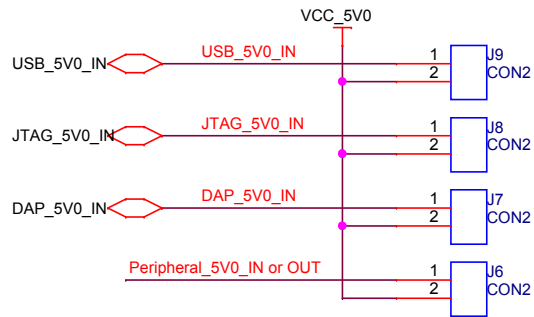

5V Power Select:
 USB Function: Closed J9
 JTAG Module: Closed J8
 DAP Module: Closed J7
 Peripheral 5V0 IN or OUT: Closed J6

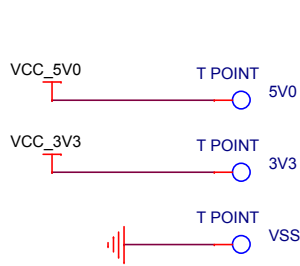

TEST POINT

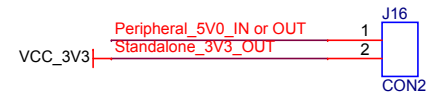
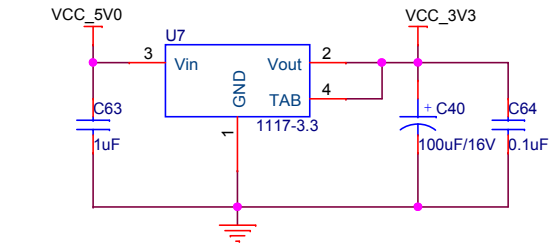
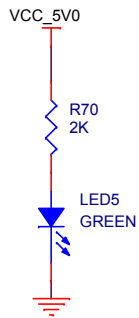

J16: Conect to Peripheral Board
 For 5V Input or 5VOutput or 3V3 Output

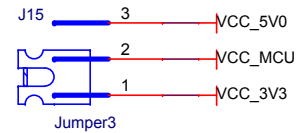

J15:
 VCC_MCU 3V3: Closed Pin2 to Pin1
 VCC_MCU 5V0: Closed Pin2 to Pin3

Spanision Inc.

Author: Rex.Cao



Title

(SCH)SK-FM4-U120-9B560(-MEM)

Size
A4

Document Number
POWER

Rev
V1.3.0

Date: Wednesday, September 03, 2014

Sheet 9 of 9