

REVISIONS						
PAGE	ZONE	REV	ECN	DESCRIPTION	DATE	APPROVED
-	-	**	465550	NEW SPEC	6/31/03	
-	-	*A	565977	ADDED TABLE FOR TRAY P/ NUMBER FOR BLACK, RED AND BLUE	11/12/06	
-	-	*B	3778629	SUNSET REVIEW. CHANGE DRAWING TEMPLATE ALIGNED TO 001-49215	10/14/12	
-	-	*C	4577773	CORRECTED DIMENSIONS.	11/25/14	

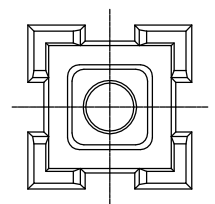
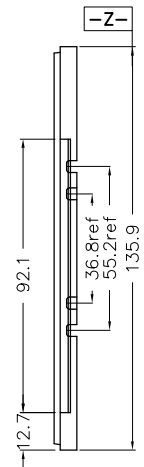
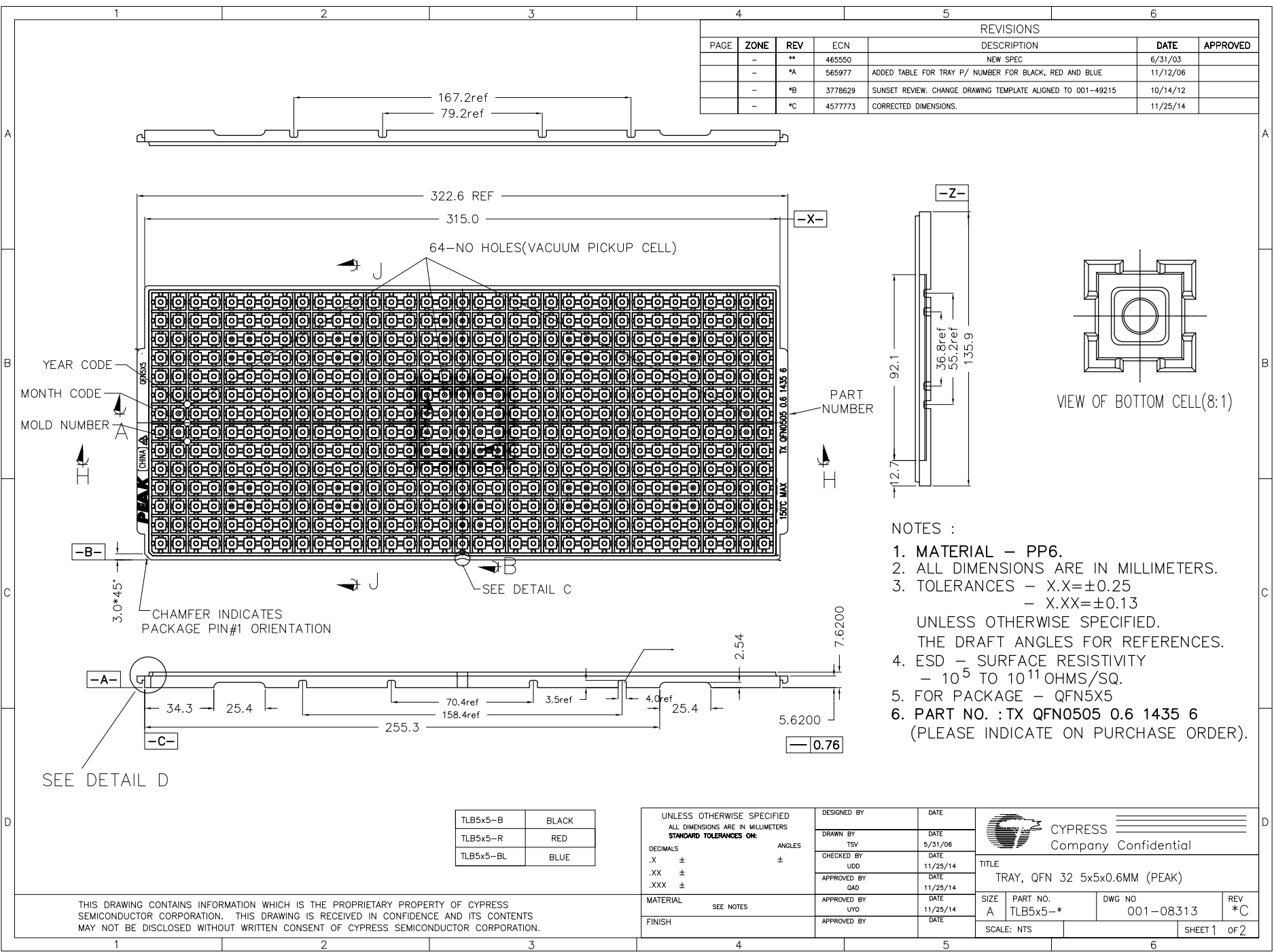

VIEW OF BOTTOM CELL(8:1)

NOTES :

- MATERIAL - PP6.
- ALL DIMENSIONS ARE IN MILLIMETERS.
- TOLERANCES - X.X=±0.25
- X.XX=±0.13
UNLESS OTHERWISE SPECIFIED.
- ESD - SURFACE RESISTIVITY
- 10⁵ TO 10¹¹ OHMS/SQ.
- FOR PACKAGE - QFN5X5
- PART NO. : TX QFN0505 0.6 1435 6
(PLEASE INDICATE ON PURCHASE ORDER).

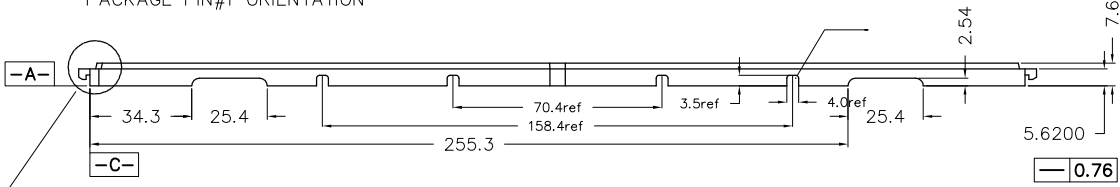

SEE DETAIL D

TLB5x5-B	BLACK
TLB5x5-R	RED
TLB5x5-BL	BLUE

UNLESS OTHERWISE SPECIFIED ALL DIMENSIONS ARE IN MILLIMETERS STANDARD TOLERANCES ON:	
DECIMALS	ANGLES
.X ±	±
.XX ±	
.XXX ±	
MATERIAL	SEE NOTES
FINISH	

DESIGNED BY	DATE
DRAWN BY	DATE
CHECKED BY	DATE
APPROVED BY	DATE
APPROVED BY	DATE
APPROVED BY	DATE

CYPRESS
 Company Confidential

TITLE
 TRAY, QFN 32 5x5x0.6MM (PEAK)

SIZE	PART NO.	DWG NO	REV
A	TLB5x5-*	001-08313	*C

SCALE: NTS SHEET 1 OF 2

THIS DRAWING CONTAINS INFORMATION WHICH IS THE PROPRIETARY PROPERTY OF CYPRESS SEMICONDUCTOR CORPORATION. THIS DRAWING IS RECEIVED IN CONFIDENCE AND ITS CONTENTS MAY NOT BE DISCLOSED WITHOUT WRITTEN CONSENT OF CYPRESS SEMICONDUCTOR CORPORATION.

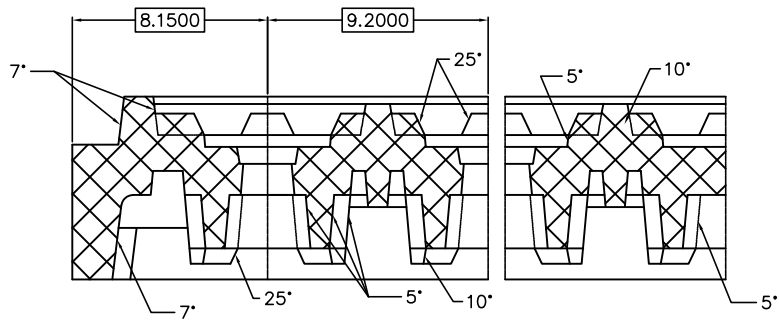
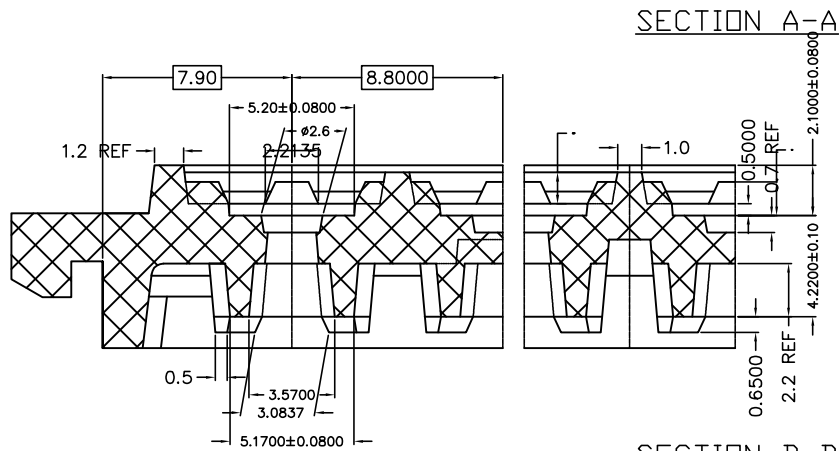

DETAIL C (BOTTOM VIEW)
NOTE: SCALLOP IS CENTERED ON SIDE OF TRAY

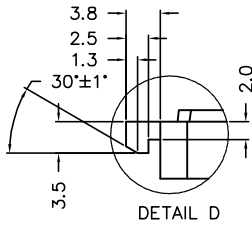

DETAIL D

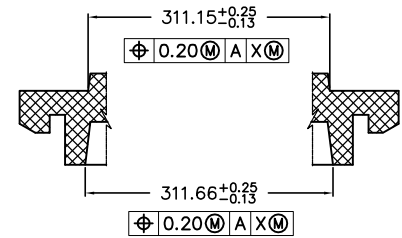

SECTION H-H

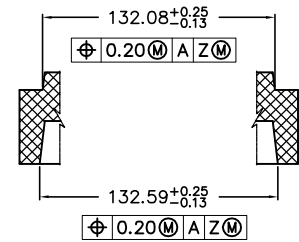

SECTION J-J



TITLE TRAY, QFN 32 5x5x0.6MM (PEAK)			
SIZE A	PART NO. TLB5x5-*	DWG NO 001-08313	REV *C
SCALE: NTS		SHEET 2 OF 2	

THIS DRAWING CONTAINS INFORMATION WHICH IS THE PROPRIETARY PROPERTY OF CYPRESS SEMICONDUCTOR CORPORATION. THIS DRAWING IS RECEIVED IN CONFIDENCE AND ITS CONTENTS MAY NOT BE DISCLOSED WITHOUT WRITTEN CONSENT OF CYPRESS SEMICONDUCTOR CORPORATION.