

Timer

2.50

Features

- Fixed-function (FF) implementation for PSoC 3 and PSoC 5 devices
- 8-, 16-, 24-, or 32-bit timer
- Optional capture input
- Enable, trigger, and reset inputs, for synchronizing with other components
- Continuous or one shot run modes

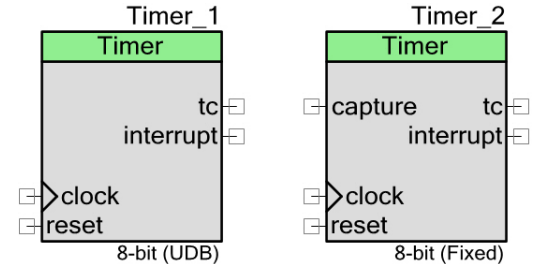

General Description

The Timer component provides a method to measure intervals. It can implement a basic timer function and offers advanced features such as capture with capture counter and interrupt/DMA generation.

For PSoC 3 and PSoC 5 devices component can be implemented using FF blocks or UDB. PSoC 4 devices support only UDB implementation. A UDB implementation typically has more features than an FF implementation. If the design is simple enough, consider using FF and save UDB resources for other purposes.

The following table shows the major feature differences between FF and UDB. There are also many specific functional differences between the FF and UDB implementations and differences between the FF implementation in different devices. See the [Configurations](#) section for detailed timing waveforms for the various implementations.

Feature	FF	UDB
Number of bits	8 or 16	8, 16, 24, or 32
Run mode	Continuous or one shot	Continuous, one shot, or one shot halt on interrupt
Count mode	Down only	Down only
Enable input	Yes (hardware or software enable)	Yes (hardware or software enable)
Capture input	Yes	Yes
Capture mode	Rising edge only	Rising edge, falling edge, either edge, or software controlled
Capture FIFO	No (one capture register)	Yes (up to four captures)

Feature	FF	UDB
Trigger input	No	Yes
Trigger mode	None	Rising edge, falling edge, either edge, or software controlled
Reset input	Yes	Yes
Terminal count output	Yes	Yes
Interrupt output	Yes (PSoC 3 only)	Yes
Interrupt conditions	TC, capture	TC, capture, and FIFO full
Capture output	No	Yes
Period register	Yes	Yes
Period reload	Yes (always reload on reset or TC)	Yes (always reload on reset or TC)
Clock input	Limited to digital clocks in the clock system	Any signal

When to Use a Timer

The default use of the Timer is to generate a periodic event or interrupt signal. However, there are other potential uses:

- Create a clock divider by driving a clock into the clock input and using the terminal count output as the divided clock output.
- Measure the length of time between hardware events by driving a clock into the clock input and driving the test signal to the enable or capture input.

Note A Counter component is better used in situations focused on counting events. A PWM component is better used in situations requiring multiple compare outputs with more control features like center alignment, output kill, and dead band outputs.

A Timer is typically used to record the number of clock cycles between events. An example of this is measuring the number of clocks between two rising edges as might be generated by a tachometer sensor. A more complex use is to measure the period and duty cycle of a PWM input. For PWM measurement, the Timer component is configured to start on a rising edge, capture the next falling edge, and then capture and stop on the next rising edge. An interrupt on the final capture signals the CPU that all of the captured values are ready in the FIFO.

Input/Output Connections

This section describes the various input and output connections for the Timer. Some I/Os may be hidden on the symbol under the conditions listed in the description of that I/O.

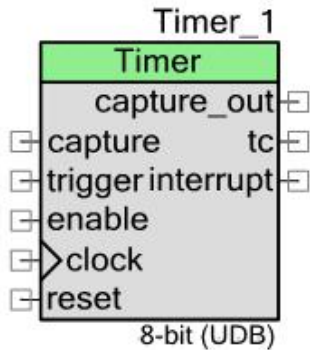

Note All signals are active high unless otherwise specified.

Input	May Be Hidden	Description
clock	N	The clock input defines the operating frequency of the Timer component. That is, the timer period counter value is decremented on the rising edge of this input while the Timer component is enabled.
reset	N	This input is a synchronous reset. It requires at least one rising edge of the clock to implement the resets of the counter value and the capture counter. It resets the period counter to the period value and also resets the capture counter. For the fixed-function implementation the reset signal forces the counter to load from the period register in active mode only. Namely if timer is started by call the Timer_Start() function.
enable	Y	This input is the Timer hardware enable. This connection enables the period counter to decrement on each rising edge of the clock. If this input is low the outputs are still active but the Timer component does not change states. This input is visible when the Enable Mode parameter is set to Hardware Only or Software and Hardware .
capture	Y	The capture input captures the current count value to a capture register or FIFO. The input is visible if the Capture Mode parameter is set to any mode other than None . Capture may take place on a rising edge, falling edge, or either edge applied to this input, depending on the Capture Mode setting. The capture input is sampled on the clock input. No values are captured if the Timer is disabled. The capture input may be left floating with no external connection. If nothing is connected to the capture line, the component will assign it a constant logic 0. Note The capture status bit in the timer status register clears on read. This causes a side effect on the fixed-function timer in PSoC 5 (non LP) devices. If this bit is cleared before the next rising edge of the clock input, then the counter value will not be captured in the capture register.
trigger	Y	The trigger input enables the timer to start counting based on configurable hardware events. The input is visible if the Trigger Mode parameter is set to any mode other than None . It causes the Timer to delay counting until the appropriate edge is detected. The trigger edge is not captured nor does it generate an interrupt.

Output	May Be Hidden	Description
tc	N	Terminal count is a synchronous output that indicates that the count value equals zero. The output is synchronous to the clock input of the Timer. The exact timing of this output depends on the device and whether a UDB or FF implementation is used.
interrupt	N	The interrupt output is driven by the interrupt sources configured in the hardware. All sources are ORed together to create the final output signal. The sources of the interrupt can be: Terminal Count, Capture, or FIFO full. After an interrupt is triggered, the interrupt output remains asserted until the status register is read. The interrupt connection is not supported for the FF implementation on PSoC 5. If you need this functionality, you can connect an interrupt component to the tc signal or you can use the UDB implementation.
capture_out	Y	The capture_out output is an indicator of when a hardware capture has been triggered. This signal is available for the UDB implementation only. This output is synchronized to the clock input of the Timer.

Schematic Macro Information

The default Timer in the Component Catalog is a schematic macro using a Timer component with default settings. It is connected to bus clock and a Logic Low component.

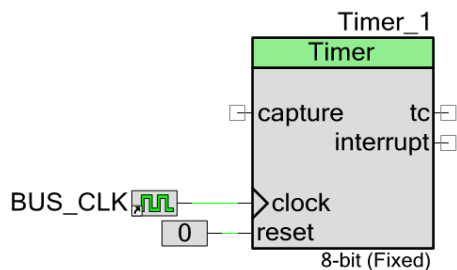

Component Parameters

Drag a Timer onto your design and double-click it to open the **Configure** dialog.

Hardware versus Software Configuration Options

Hardware configuration options change the way the project is synthesized and placed in the hardware. You must rebuild the hardware if you make changes to any of these options. Software configuration options do not affect synthesis or placement. When setting these parameters before build time you are setting their initial values. These may be modified at any time with the APIs provided. Most parameters described in the next sections are hardware options. The software options are noted as such.



Configure Tab

Resolution

The **Resolution** parameter defines the bit-width resolution of the Timer. This value may be set to 8, 16, 24, or 32 for maximum count values of 255, 65535, 16777215, and 4294967295 respectively. For FF implementations, the resolution is limited to 8 or 16 bits.

Implementation

The **Implementation** parameter allows you to choose between a fixed-function block implementation and a UDB implementation of the Timer. If FF is selected, UDB functions are disabled.

Period (Software Option)

The **Period** parameter defines the period of the counter. The max count value (or rollover point) for the Timer component is equal to the **Period** minus one. The **Period** minus one is the initial value loaded into the period register. The software can change this register at any time with the `Timer_WritePeriod()` API. To get the equivalent result using this API, the **Period** value from the customizer, minus one, must be used as the argument in the function.

The limits of this value are defined by the **Resolution** parameter. For 8-, 16-, 24-, and 32-bit **Resolution**, the **Period** is: 2^8 , 2^{16} , 2^{24} , and 2^{32} or 256, 65536, 16777216, and 4294967296 respectively.



Trigger Mode (Software Option)

The **Trigger Mode** parameter configures the implementation of the trigger input. This parameter is only active when **Implementation** is set to **UDB**.

Trigger Mode can be set to any of the following values:

- **None** (default) – No trigger implemented and the trigger input pin is hidden
- **Rising Edge** – Trigger (enable) counting on the first rising edge of the trigger input
- **Falling Edge** – Trigger (enable) counting on the first falling edge of the trigger input
- **Either Edge** – Trigger (enable) counting on the first edge (rising or falling) of the trigger input
- **Software Controlled** – The trigger mode can be set during run time, to one of the four trigger modes listed above, using the `Timer_SetTriggerMode()` API call. The default trigger is **None** until another value is set using this API.

Capture Mode (Software Option)

The Capture Mode section contains three parameters: **Capture Mode Value**, **Enable Capture Counter**, and **Capture Count**.

Capture Mode

The **Capture Mode** parameter configures when a capture takes place. The capture input is sampled on the rising edge of the clock input. This mode can be set to any of the following values (for the fixed-function implementation, only **None** and **Rising Edge** are available):

- **None** – No capture implemented and the capture input pin is hidden
- **Rising Edge** – Capture the counter value on a rising edge of the capture input with respect to the clock input.
- **Falling Edge** – Capture the counter value on a falling edge of the capture input with respect to the clock input.
- **Either Edge** – Capture the counter value on either edge of the capture input with respect to the clock input.
- **Software Controlled** – The capture mode can be set during run time, to one of the four capture modes listed above, using the `Timer_SetCaptureMode()` API call. The default trigger is **None** until another value is set using this API.

Enable Capture Counter (Software Option)

The **Enable Capture Counter** parameter is used to define how many capture events happen before the counter is actually captured. For example, it may be necessary to capture every third

event, in which case the capture counter must be set to a value of 3. This parameter is only available for a UDB implementation.

Capture Count (Software Option)

The **Capture Count** parameter sets the initial number of capture events that occur before the counter is actually captured. It can be set to a value from 2 to 127. The capture count value may be modified at run time by calling the API function `Timer_SetCaptureCount()`. This parameter is only available for a UDB implementation.

Enable Mode

The **Enable Mode** parameter configures the enable implementation of the Timer. The enable input is sampled on the rising edge of the clock input. This mode can be set to any of the following values:

- **Software Only** – The Timer is enabled based on the enable bit of the control register only.
- **Hardware Only** – The Timer is enabled based on the enable input only. (UDB only)
- **Software and Hardware** – The Timer is enabled if both hardware and software enables are true.

Run Mode

The **Run Mode** parameter is used to configure the Timer component to run continuously or in a one-shot mode:

- **Continuous** – The Timer runs continuously while it is enabled.
- **One Shot** – The Timer starts counting and stops counting when zero is reached. After it is reset, it begins another cycle. On stop, for a UDB Timer, it reloads **Period** into the count register; for a fixed-function Timer the count register remains at terminal count.
- **One Shot (Halt on Interrupt)** – The Timer starts counting and stops counting when zero is reached or an interrupt occurs. After it is reset, it begins another cycle. On stop, for a UDB Timer, it reloads **Period** into the count register; for a fixed-function Timer the count register remains at terminal count.

Note In order to be sure that One Shot mode does not start prematurely, use a **Trigger Mode** to control the start time, or use some form of software enable mode (**Software Only** or **Software and Hardware**).



Interrupt (Software Option)

The **Interrupt** parameters is used to configure the initial interrupt sources. An interrupt is generated when one or more of the following selected events occur. The software can reconfigure this mode at any time; this parameter defines an initial configuration.

- **On TC** –This parameter is always active; it is cleared by default.
- **On Capture (1-4)** – Allows you to interrupt on a given number of captures; it is cleared by default.
- **On FIFO Full** – Allows you to interrupt when the capture FIFO is full; it is cleared by default.

Clock Selection

Fixed-Function Components

When configured to use the FF block in the device, the Timer component has the following restrictions:

- The clock input must be a digital clock from the clock system.
- If the frequency of the clock is to be the same as bus clock, then the clock must actually be the bus clock.

Open the **Configure** dialog of the appropriate Clock component to configure the **Clock Type** parameter as **Existing** and the **Source** parameter as **BUS_CLK**. A clock at this frequency cannot be divided from any other source, such as the master clock, IMO, and so on.

For UDB-based Components

Any digital signal from any source can be connected to the clock input. The frequency of that signal is limited to the frequency range defined in the [DC and AC Electrical Characteristics \(UDB Implementation\)](#) section of this datasheet.

Application Programming Interface

Application Programming Interface (API) routines allow you to configure the component using software. The following table lists and describes the interface to each function. The subsequent sections cover each function in more detail.

By default, PSoC Creator assigns the instance name “Timer_1” to the first instance of a component in a given design. You can rename it to any unique value that follows the syntactic rules for identifiers. The instance name becomes the prefix of every global function name, variable, and constant symbol. For readability, the instance name used in the following table is “Timer”.

Function	Description
Timer_Start()	Sets the initVar variable, calls the Timer_Init() function, and then calls the Enable function.
Timer_Stop()	Disables the Timer.
Timer_SetInterruptMode()	Enables or disables the sources of the interrupt output.
Timer_ReadStatusRegister()	Returns the current state of the status register.
Timer_ReadControlRegister()	Returns the current state of the control register.
Timer_WriteControlRegister()	Sets the bit-field of the control register.
Timer_WriteCounter()	Writes a new value directly into the counter register. (UDB only)
Timer_ReadCounter()	Forces a capture, and then returns the capture value.
Timer_WritePeriod()	Writes the period register.
Timer_ReadPeriod()	Reads the period register.
Timer_ReadCapture()	Returns the contents of the capture register or the output of the FIFO.
Timer_SetCaptureMode()	Sets the hardware or software conditions under which a capture will occur.
Timer_SetCaptureCount()	Sets the number of capture events to count before capturing the counter register to the FIFO.
Timer_ReadCaptureCount()	Reports the current setting of the number of capture events.
Timer_SoftwareCapture()	Forces a capture of the counter to the capture FIFO
Timer_SetTriggerMode()	Sets the hardware or software conditions under which a trigger will occur.
Timer_EnableTrigger()	Enables the trigger mode of the timer.
Timer_DisableTrigger()	Disables the trigger mode of the timer.
Timer_SetInterruptCount()	Sets the number of captures to count before an interrupt is triggered.
Timer_ClearFIFO()	Clears the capture FIFO.
Timer_Sleep()	Stops the Timer and saves its current configuration.



Function	Description
Timer_Wakeup()	Restores the Timer configuration and re-enables the Timer.
Timer_Init()	Initializes or restores the Timer per the Configure dialog settings.
Timer_Enable()	Enables the Timer.
Timer_SaveConfig()	Saves the current configuration of the Timer.
Timer_RestoreConfig()	Restores the configuration of the Timer.

Global Variables

Variable	Description
Timer_initVar	<p>Indicates whether the Timer has been initialized. The variable is initialized to 0 and set to 1 the first time Timer_Start() is called. This allows the component to restart without reinitialization after the first call to the Timer_Start() routine.</p> <p>If reinitialization of the component is required, then the Timer_Init() function can be called before the Timer_Start() or Timer_Enable() function.</p>

void Timer_Start(void)

Description: This is the preferred method to begin component operation. Timer_Start() sets the initVar variable, calls the Timer_Init() function, and then calls the Timer_Enable() function.

Parameters: None

Return Value: None

Side Effects: If the initVar variable is already set, this function only calls the Timer_Enable() function.

void Timer_Stop(void)

Description: For fixed-function implementations this disables the Timer and powers it down. For UDB implementations the Timer is disabled only in software enable modes.

Parameters: None

Return Value: None

Side Effects: Because fixed-function Timers are powered down by this function, the TC output will be driven low.



void Timer_SetInterruptMode(uint8 interruptMode)

- Description:** Enables or disables the sources of the interrupt output.
- Parameters:** uint8: Interrupt sources. For bit definitions, refer to the [Mode Register](#) section of this datasheet.
- Return Value:** None
- Side Effects:** The bit locations are different between FF and UDB. Mask #defines are provided to encapsulate the differences.

uint8 Timer_ReadStatusRegister(void)

- Description:** Returns the current state of the status register.
- Parameters:** None
- Return Value:** uint8: Current status register value
For bit definitions, refer to the [Status Register](#) section of this datasheet.
- Side Effects:** Some of these bits are cleared when status register is read. Clear-on-read bits are defined in the [Status Register](#) section of this datasheet.

uint8 Timer_ReadControlRegister(void)

- Description:** Returns the current state of the control register. This API is not available in the special case when the control register is not required (UDB implementation, enable mode is hardware only, capture mode not software controlled, and trigger mode not software controlled).
- Parameters:** None
- Return Value:** uint8: Control register bit field
For bit definitions, refer to the [Control Register](#) section of this datasheet.
- Side Effects:** None

void Timer_WriteControlRegister(uint8 control)

- Description:** Sets the bit field of the control register. This API is not available in the special case when the control register is not required (UDB implementation, enable mode is hardware only, capture mode not software controlled, and trigger mode not software controlled).
- Parameters:** uint8: Control register bit field
For bit definitions, refer to the [Control Register](#) section of this datasheet.
- Return Value:** None
- Side Effects:** None



void Timer_WriteCounter(uint8/16/32 counter)

Description: Writes a new value directly into the counter register. This function is available only for the UDB implementation.

Parameters: uint8/16/32: New counter value. For 24-bit Timers, the parameter is uint32.

Return Value: None

Side Effects: Overwrites the counter value. This can cause undesired behavior on the terminal count output or period width. This is not an atomic write and the function may be interrupted. The Timer should be disabled before calling this function.

uint8/16/32 Timer_ReadCounter(void)

Description: Forces a capture and then returns the capture value.

Parameters: None

Return Value: uint8/16/32: Current counter value. For 24-bit Timers, the return type is uint32.

Side Effects: Returns the contents of the capture register or the output of the FIFO (UDB only).

void Timer_WritePeriod(uint8/16/32 period)

Description: Writes the period register.

Parameters: uint8/16/32: New period value. For 24-bit Timers, the parameter is uint32.

Return Value: None

Side Effects: The period of the Timer does not change until the counter is reloaded from the period register.

uint8/16/32 Timer_ReadPeriod(void)

Description: Reads the period register.

Parameters: None

Return Value: uint8/16/32: Current period value. For 24-bit Timers, the return type is uint32.

Side Effects: None



uint8/16/32 Timer_ReadCapture(void)

- Description:** Returns the contents of the capture register or the output of the FIFO (UDB).
- Parameters:** None
- Return Value:** uint8/16/32: Current capture value. For 24-bit Timers, the return type is uint32.
- Side Effects:** In the UDB implementation, the value is removed from the FIFO.

void Timer_SetCaptureMode(uint8 captureMode)

- Description:** Sets the capture mode. This function is available only for the UDB implementation and when the **Capture Mode** parameter is set to **Software Controlled**.
- Parameters:** uint8: Enumerated capture mode. Refer also to the [Control Register](#) section:
- ```

Timer__B_TIMER__CM_NONE
Timer__B_TIMER__CM_RISINGEDGE
Timer__B_TIMER__CM_FALLINGEDGE
Timer__B_TIMER__CM_EITHEREDGE
Timer__B_TIMER__CM_SOFTWARE

```
- Return Value:** None
- Side Effects:** None

**void Timer\_SetCaptureCount(uint8 captureCount)**

- Description:** Sets the number of capture events to count before a capture is performed. This function is available only for the UDB implementation and when the **Enable Capture Counter** parameter is selected in the Configure dialog.
- Parameters:** uint8 captureCount: The number of capture events you want to count before capturing the counter value to the capture FIFO. A value from 2 to 127 is valid.
- Return Value:** None
- Side Effects:** None

**uint8 Timer\_ReadCaptureCount(void)**

- Description:** Reads the current value setting for the captureCount parameter as set in the Timer\_SetCaptureCount() function. This function is only available for the UDB implementation and when the **Enable Capture Counter** parameter is selected in the Configure dialog.
- Parameters:** None
- Return Value:** uint8: Current capture count
- Side Effects:** None



**void Timer\_SoftwareCapture(void)**

**Description:** Forces a software capture of the current counter value to the FIFO. This function is available only for UDB implementation.

**Parameters:** None

**Return Value:** None:

**Side Effects:** None

**void Timer\_SetTriggerMode(uint8 triggerMode)**

**Description:** Sets the trigger mode. This function is available only for UDB implementation and when Trigger Mode parameter is set to Software Controlled.

**Parameters:** uint8: Enumerated capture mode. Refer also to the [Control Register](#) section.

```

Timer__B_TIMER__TM_NONE
Timer__B_TIMER__TM_RISINGEDGE
Timer__B_TIMER__TM_FALLINGEDGE
Timer__B_TIMER__TM_EITHEREDGE
Timer__B_TIMER__TM_SOFTWARE

```

**Return Value:** None

**Side Effects:** None

**void Timer\_EnableTrigger(void)**

**Description:** Enables the trigger. This function is available only when **Trigger Mode** is set to **Software Controlled**.

**Parameters:** None

**Return Value:** None

**Side Effects:** None

**void Timer\_DisableTrigger(void)**

**Description:** Disables the trigger. This function is available only when **Trigger Mode** is set to **Software Controlled**.

**Parameters:** None

**Return Value:** None

**Side Effects:** None



## void Timer\_SetInterruptCount(uint8 interruptCount)

- Description:** Sets the number of captures to count before an interrupt is generated for the InterruptOnCapture source. This function is available only when InterruptOnCaptureCount is enabled.
- Parameters:** uint8 interruptCount: The number of capture events to count before the interrupt on capture is generated. A value from 0 to 3 is valid.
- Return Value:** None
- Side Effects:** None

## void Timer\_ClearFIFO(void)

- Description:** Clears the capture FIFO. This function is available only for the UDB implementation. Refer to [UDB FIFOs](#) in the [MISRA Compliance](#)

This section describes the MISRA-C:2004 compliance and deviations for the component. There are two types of deviations defined:

- project deviations – deviations that are applicable for all PSoC Creator components
- specific deviations – deviations that are applicable only for this component

This section provides information on component-specific deviations. Project deviations are described in the MISRA Compliance section of the *System Reference Guide* along with information on the MISRA compliance verification environment.

The Timer component does not have any specific deviations.

Functional Description section of this datasheet.

- Parameters:** None
- Return Value:** None
- Side Effects:** None



## void Timer\_Sleep(void)

**Description:** This is the preferred routine to prepare the component for sleep. Timer\_Sleep() saves the current component state. Then it calls the Timer\_Stop() function and calls Timer\_SaveConfig() to save the hardware configuration.

Call the Timer\_Sleep() function before calling the CyPmSleep() or the CyPmHibernate() function. Refer to the PSoC Creator *System Reference Guide* for more information about power-management functions.

**Parameters:** None

**Return Value:** None

**Side Effects:** For the FF implementation, all registers are retained across low-power modes. For the UDB implementation, the control register and counter value register are saved and restored. Additionally when calling Timer\_Sleep(), the enable state is stored in case you call Timer\_Sleep() without calling Timer\_Stop().

## void Timer\_Wakeup(void)

**Description:** This is the preferred routine to restore the component to the state when Timer\_Sleep() was called. The Timer\_Wakeup() function calls the Timer\_RestoreConfig() function to restore the configuration. If the component was enabled before the Timer\_Sleep() function was called, the Timer\_Wakeup() function also re-enables the component.

**Parameters:** None

**Return Value:** None

**Side Effects:** Calling the Timer\_Wakeup() function without first calling the Timer\_Sleep() or Timer\_SaveConfig() function may produce unexpected behavior.

## void Timer\_Init(void)

**Description:** Initializes or restores the component according to the customizer Configure dialog settings. It is not necessary to call Timer\_Init() because the Timer\_Start() routine calls this function and is the preferred method to begin component operation..

**Parameters:** None

**Return Value:** None

**Side Effects:** All registers will be set to values according to the customizer Configure dialog.





## void Timer\_Enable(void)

**Description:** Activates the hardware and begins component operation. It is not necessary to call Timer\_Enable() because the Timer\_Start() routine calls this function, which is the preferred method to begin component operation. This function enables the Timer for either of the software controlled enable modes.

**Parameters:** None

**Return Value:** None

**Side Effects:** If the **Enable Mode** parameter is set to **Hardware Only**, this function has no effect on the operation of the Timer.

## void Timer\_SaveConfig(void)

**Description:** This function saves the component configuration and nonretention registers. It also saves the current component parameter values, as defined in the Configure dialog or as modified by appropriate APIs. This function is called by the Timer\_Sleep() function.

**Parameters:** None

**Return Value:** None

**Side Effects:** None

## void Timer\_RestoreConfig(void)

**Description:** This function restores the component configuration and nonretention registers. It also restores the component parameter values to what they were before calling the Timer\_Sleep() function.

**Parameters:** None

**Return Value:** None

**Side Effects:** Calling this function without first calling the Timer\_Sleep() or Timer\_SaveConfig() function may produce unexpected behavior.

## Sample Firmware Source Code

PSoC Creator provides many example projects that include schematics and example code in the Find Example Project dialog. For component-specific examples, open the dialog from the Component Catalog or an instance of the component in a schematic. For general examples, open the dialog from the Start Page or **File** menu. As needed, use the **Filter Options** in the dialog to narrow the list of projects available to select.

Refer to the “Find Example Project” topic in the PSoC Creator Help for more information.



## MISRA Compliance

This section describes the MISRA-C:2004 compliance and deviations for the component. There are two types of deviations defined:

- project deviations – deviations that are applicable for all PSoC Creator components
- specific deviations – deviations that are applicable only for this component

This section provides information on component-specific deviations. Project deviations are described in the MISRA Compliance section of the *System Reference Guide* along with information on the MISRA compliance verification environment.

The Timer component does not have any specific deviations.

## Functional Description

As described previously, the Timer component can be configured for multiple uses. This section describes those configurations in more detail.

### General Operation

On each rising edge of the clock input, the Timer component always counts down. It reloads the counter register from the period register on the next clock edge after the counter reaches a value of zero.

The timer remains disabled until enabled by hardware or software, depending on the configuration setting. The component cannot be used until `Timer_Start()` is called because this function sets the registers for the defined configuration.

### Timer Outputs

The counter register can be monitored and reloaded. The `tc` output is available to monitor the current value of the counter register; it is high while the counter is zero.

### Timer Inputs

A capture operation can be done in either hardware or firmware. The current value in the counter register is copied into either a capture register or a FIFO. Firmware can then read the captured value at a later time.

Reset and enable features allow the Timer component to be synchronized to other components. The Timer component counts only when enabled and not held in reset. Counting can also be initiated on a trigger input event. It can be reset or enabled by either hardware or firmware. All triggering is hardware.

**Note** All of the inputs for the FF Timer implementations (capture, reset, and enable) are double synchronized in the FF Timer. The synchronizer is run at `BUS_CLK` speed. This results in a delay between when these signals are applied and when they take effect. The delay depends on



the ratio between BUS\_CLK and the clock that runs the Timer. All waveforms shown for the FF implementations show the signal after it has been synchronized.

### Timer Interrupt

An interrupt output is available to communicate event occurrences to the CPU or to other components. You can set the interrupt to be active on a combination of one or more events. You should design the interrupt handler carefully so that you can determine the source of the interrupt and whether it is edge- or level-sensitive, and clear the source of the interrupt.

### Timer Registers

There are three registers: mode, status, and control. Refer to the [Registers](#) section.

### Configurations

#### Default Configuration

When you drag a Timer component onto a PSoC Creator schematic, the default configuration is an 8-bit, FF timer that decrements the counter register on a rising edge at the clock input. [Figure 1](#) shows the default schematic macro and Configure dialog settings.

**Figure 1. Default Timer Configuration**

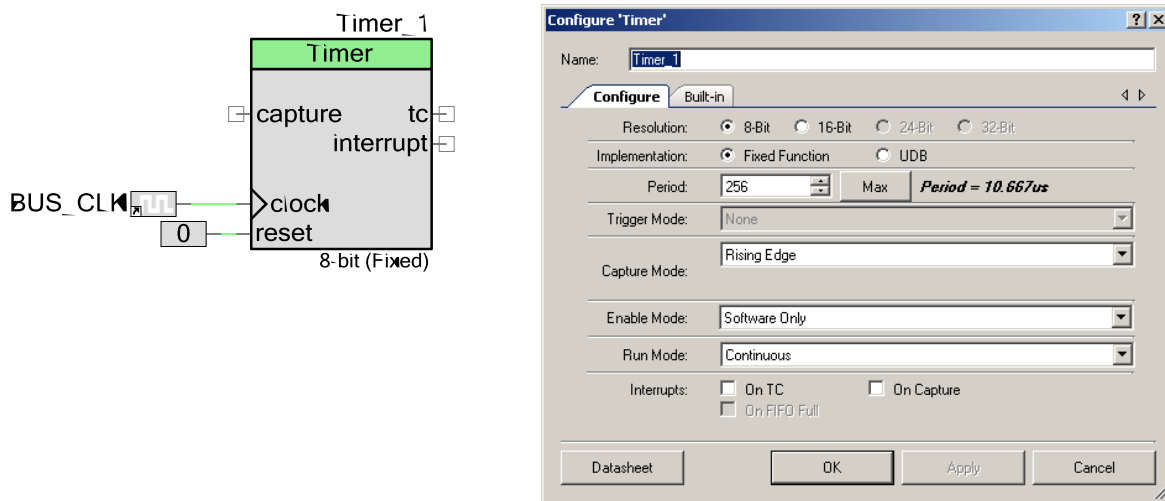

The exact functionality of this timer differs for different implementations and different silicon. The following figures show the functionality of this timer with the UDB implementation and for the FF implementation on different silicon.

The functionality of the default configuration when configured for the UDB implementation is shown in [Figure 2](#).



The counter is preloaded during Timer configuration and it is reloaded each time the counter reaches zero. In the default configuration, the **Period** is set to 256. This results in 0xFF being loaded into the counter because counting from 0xFF through 0 yields a period of 256.

The reset signal forces the counter to reload from its period register. The counter is held at this state until the reset signal is removed.

Terminal count indicates that the timer has counted down to zero. It is active on the clock cycle that follows the clock cycle where the count value has reached zero. The terminal count signal is not generated based on a reset event.

By default, the capture functionality is configured to capture on every rising edge of the capture input. Regardless of the width of the capture pulse, a single value is captured. In this example, the values 0xFE and 0x01 are captured and can be read by the CPU.

**Figure 2. Default UDB Timer Implementation Example Waveform**

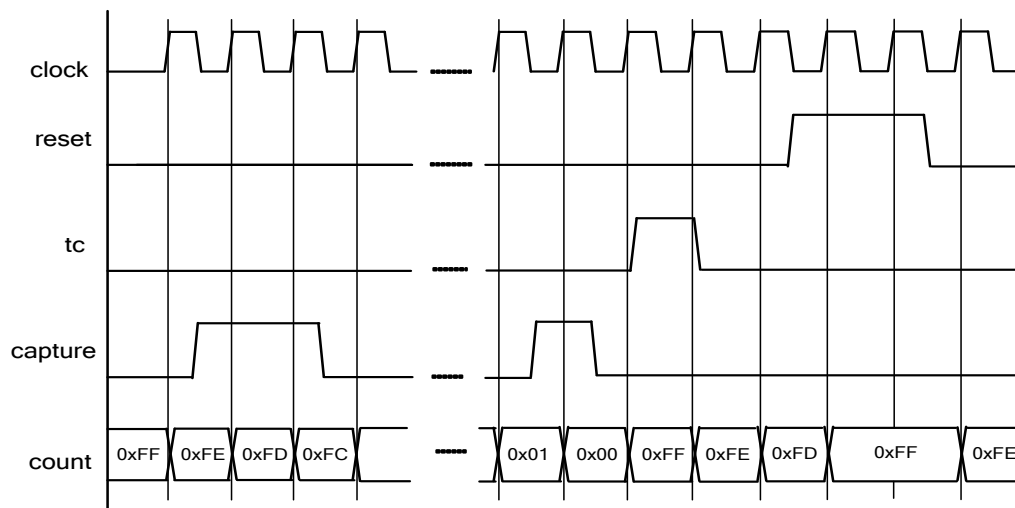

The functionality of the default configuration when configured for the fixed-function implementation on PSoC 3 is shown in [Figure 3](#).

For the fixed-function implementations, the counter value is not preloaded during configuration time; instead, the counter starts with a value of zero. For PSoC 3 this results in a three-cycle initial lag time for the FF implementation versus the UDB implementation. This is a two-cycle delay before the Timer starts counting and one cycle to load the counter from the period register. After the Timer is running, the period is the same as the UDB implementation.

The reset signal forces the counter to load from the period register and remain at that count until reset is removed. Once reset is removed, there is a two-cycle lag before the counter begins counting down.

Terminal count indicates that the timer has counted down to zero. It is active on the clock cycle that follows the clock cycle where the count value has reached zero. The terminal count signal is not generated based on a reset event or because of the initial counter value of zero.



By default, the capture functionality is configured to capture on every rising edge of the capture input. Regardless of the width of the capture pulse, a single value is captured. In this example, the values 0xFF and 0x01 are captured and can be read by the CPU. This functionality is the same as the UDB implementation.

**Figure 3. Default PSoC 3 FF Timer Implementation Example Waveform**

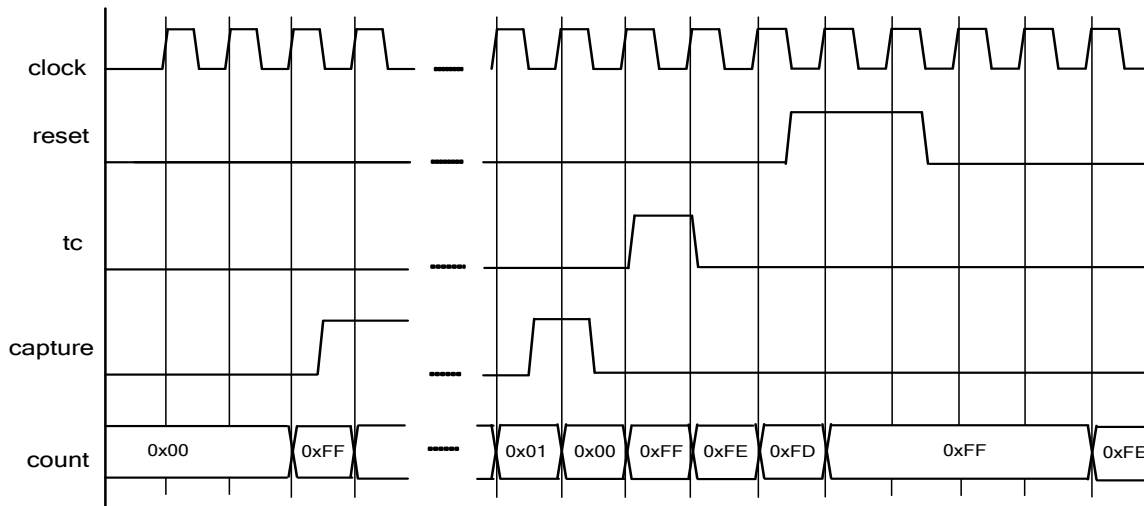

The functionality of the default configuration when configured for the fixed function implementation on PSoC 5 is shown in [Figure 4](#).

For fixed-function implementations, the counter value is not preloaded during configuration time; instead, the counter starts with a value of zero. For PSoC 5 this results in a two-cycle initial lag time for the FF implementation versus the UDB implementation. This is a one-cycle delay before the Timer starts counting and one cycle to load the counter from the period register. After the Timer is running, the period is the same as the UDB implementation.

The reset signal forces the counter to clear and it remains at zero until reset is removed. The functionality after reset looks the same as the functionality from the initial state with the first period being two cycles longer than the UDB implementation.

Terminal count indicates that the timer has a value of zero. When combined with the initial value of the counter and the value when reset, this results in a two-cycle TC pulse at initialization and after a reset. TC is held low while reset is active, but then is high for two cycles after the reset is removed.

By default, the capture functionality is configured to capture on every rising edge of the capture input. Regardless of the width of the capture pulse, a single value is captured. In this example, the values 0xFF and 0x01 are captured and can be read by the CPU. This functionality is the same as the UDB implementation.



**Figure 4. Default PSoC 5 FF Timer Implementation Example Waveform**

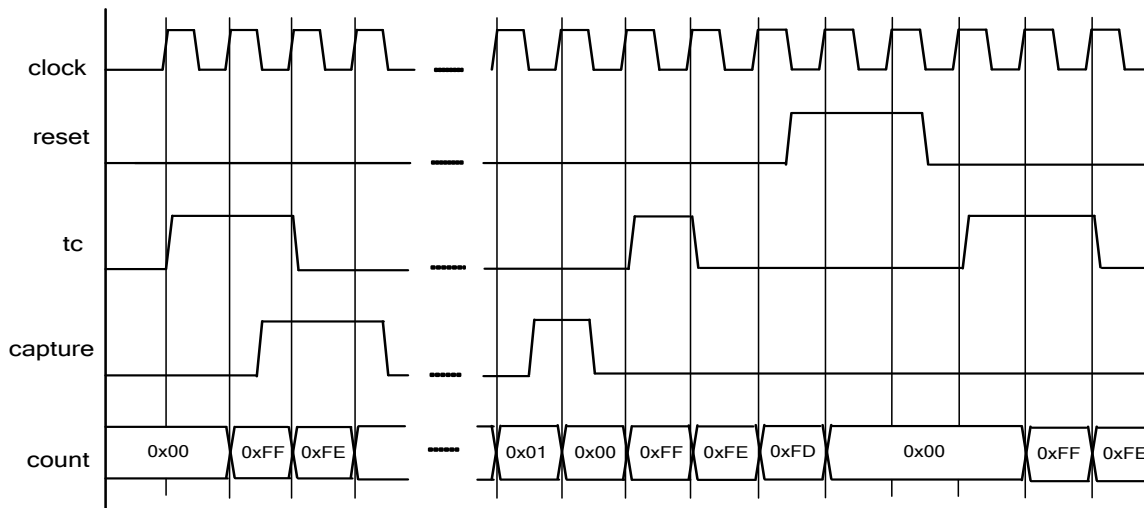

**Software and Hardware Enable Configuration**

The functionality of the hardware enable varies based on the specific implementation. The functionality of the Timer when configured for Software and Hardware enable with the UDB implementation is shown in [Figure 5](#).

The counter is decremented on every cycle when the Timer is enabled. During the cycle when the counter is reloaded from its period register, a single cycle terminal count pulse is generated. The TC signal will always be a single clock cycle pulse. Note that it occurs during the reload cycle. If the reload is delayed because the counter was disabled as it hit a zero count, the TC pulse is also delayed until the counter is re-enabled and the counter is reloaded. If the counter is forced to reload because of a reset signal, the TC pulse is not generated.

**Figure 5. SW and HW Enable UDB Timer Implementation Example Waveform**

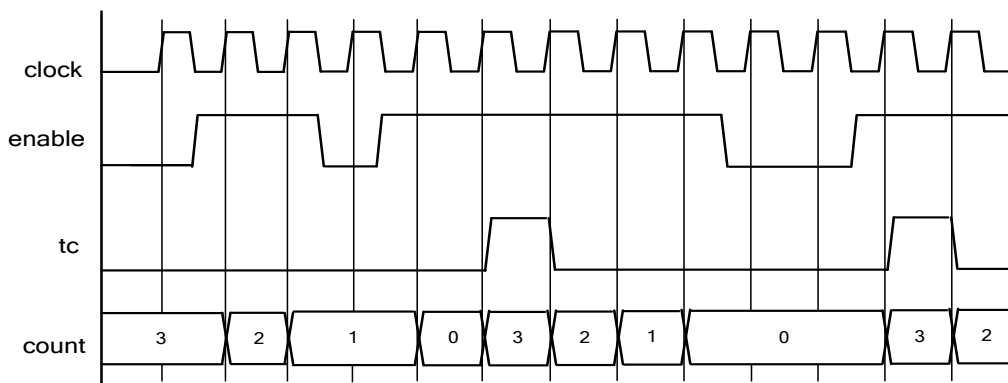

The functionality of the Timer when configured for Software and Hardware enable with the PSoC 3 FF implementation is shown in [Figure 6](#).



There is a two-clock-cycle lag between the hardware enable and the effective enable of the counter. The result is that the counter decrements if the enable signal two clock cycles earlier was high. This lag applies for both enabling and disabling the counter. During the cycle when the counter is reloaded from its period register, a single-cycle terminal count pulse is generated. The TC signal is always a single clock cycle pulse.

**Note** If the Timer has the enable signal low during the two cycles before the counter reaches zero, the TC output pulse is not generated for this period of the Timer. When the Timer is re-enabled it is reloaded without the generation of the TC signal. This is shown in the example waveform.

**Figure 6. SW and HW Enable PSoC 3 FF Timer Implementation Example Waveform**

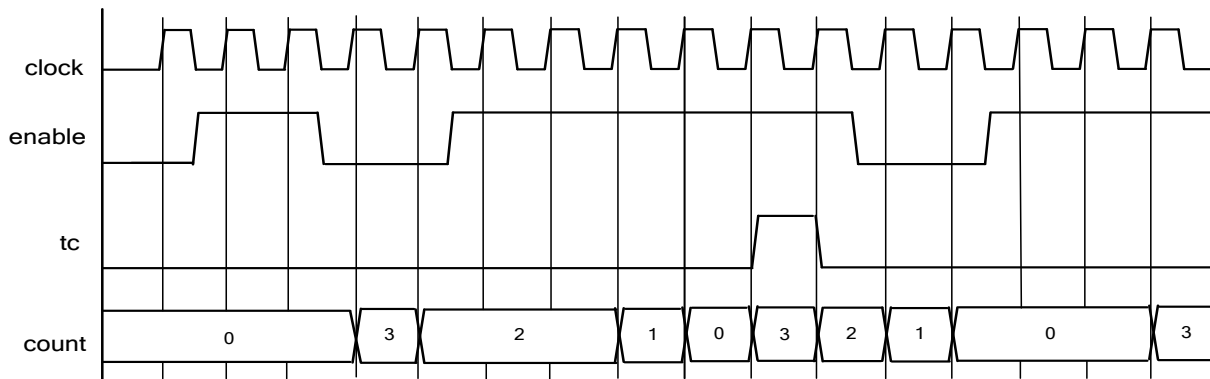

The functionality of the Timer when configured for Software and Hardware enable with the PSoC 5 FF implementation is shown in [Figure 7](#).

There is a one-clock-cycle lag between the hardware enable and the effective enable of the counter. The result is that the counter decrements if the enable signal one clock cycle earlier was high. This lag applies for both enabling and disabling the counter. The terminal count signal is generated any time that the counter value is equal to zero with a one-clock-cycle lag. This occurs at initial configuration time. The TC signal stays high if the enable signal causes the Timer to stop while the counter is equal to zero.

**Note** The hardware enable signal does not function as expected if the enable is pulsed inactive for a single cycle. A single-cycle disable pulse locks the Timer at that count until the Timer is again disabled and then re-enabled. For this reason, a hardware disable must always be for two or more cycles. A single-cycle enable functions as expected.

**Figure 7. SW and HW Enable PSoC 5 FF Timer Implementation Example Waveform**

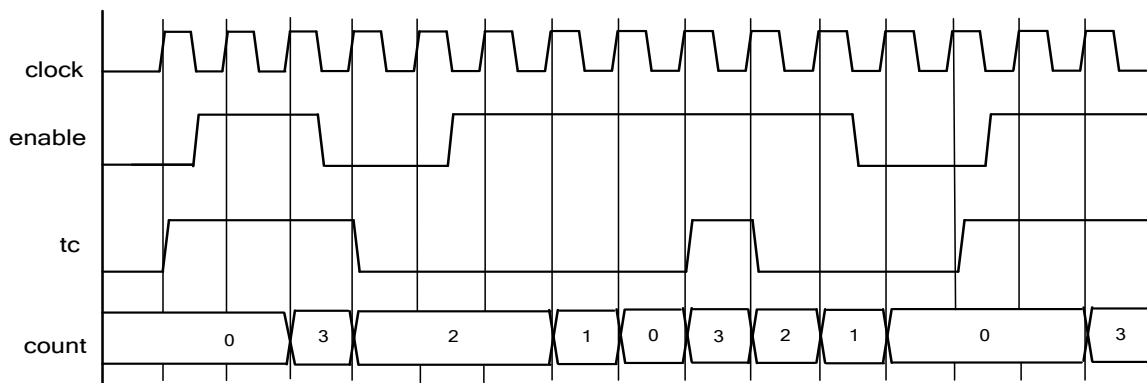

**One Shot Configuration**

The functionality of the One Shot Run Mode varies based on the specific implementation. The functionality of the Timer when configured for One Shot operation with the UDB implementation is shown in [Figure 8](#).

There is a one-clock-cycle lag between the hardware enable and the effective enable of the counter. The result is that the counter decrements if the enable signal one clock cycle earlier was high. This lag applies for both enabling and disabling the counter. This is a different behavior than in Continuous Run Mode, which counts without lag.

The TC signal is always a single-clock-cycle pulse. Note that it occurs during the reload cycle. If the reload is delayed because the counter was disabled as it hit a zero count, the TC pulse is also delayed until the counter is re-enabled and the counter is reloaded. If the counter is forced to reload because of a reset signal, the TC pulse is not generated.

After the One Shot period has completed, the Timer can be set up to run for another period by using a hardware reset. The hardware reset reloads the counter from the period register. One cycle after reset is removed, the Timer is enabled to count down again after the hardware enable is also active.



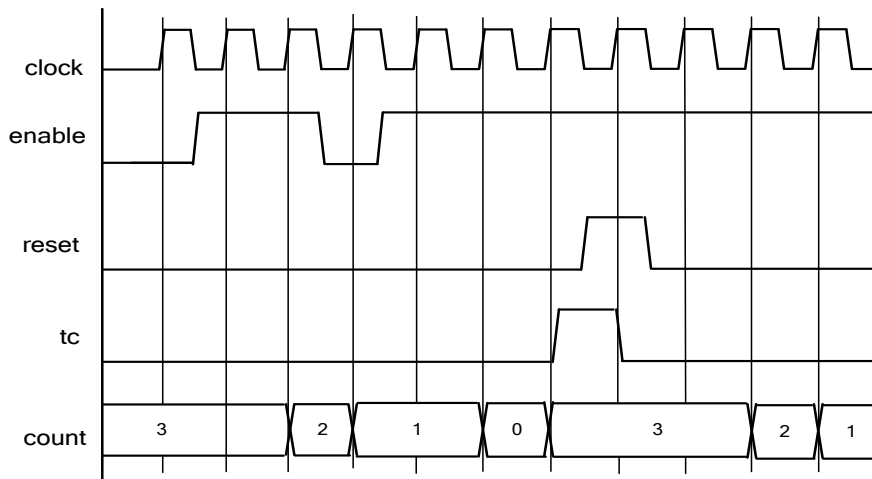

**Figure 8. One Shot Operation UDB Timer Implementation Example Waveform**

The functionality of the Timer when configured for One Shot operation with the FF implementation on PSoC 3 is shown in [Figure 9](#).

There is a two-clock-cycle lag between the hardware enable and the effective enable of the counter. The result is that the counter decrements if the enable signal two clock cycles earlier was high. This lag applies for both enabling and disabling the counter. During the cycle when the counter is reloaded from its period register, a single-cycle terminal count pulse is generated. The TC signal is always a single-clock-cycle pulse. This is identical to the operation in Continuous Run Mode.

An extra feature of the One Shot mode, for this implementation only, is that once the Timer starts counting, the first time that the enable signal goes low stops the counter at that value. To start counting again, the Timer must be reset.

After the One Shot period has completed or it has stopped because of the enable signal being disabled, the Timer can be set up to run for another period by using a hardware reset. The hardware reset reloads the counter from the period register. There is a two-cycle lag from releasing reset until the Timer is enabled to count down again.

**Note** For this implementation, only the Timer can be restarted by using the `Timer_Stop()` API followed by the `Timer_Start()` API. This allows the counter to continue to count, but it does not reload the counter value, so this method only should be used in the case where the counter has already completed a period and been reloaded.

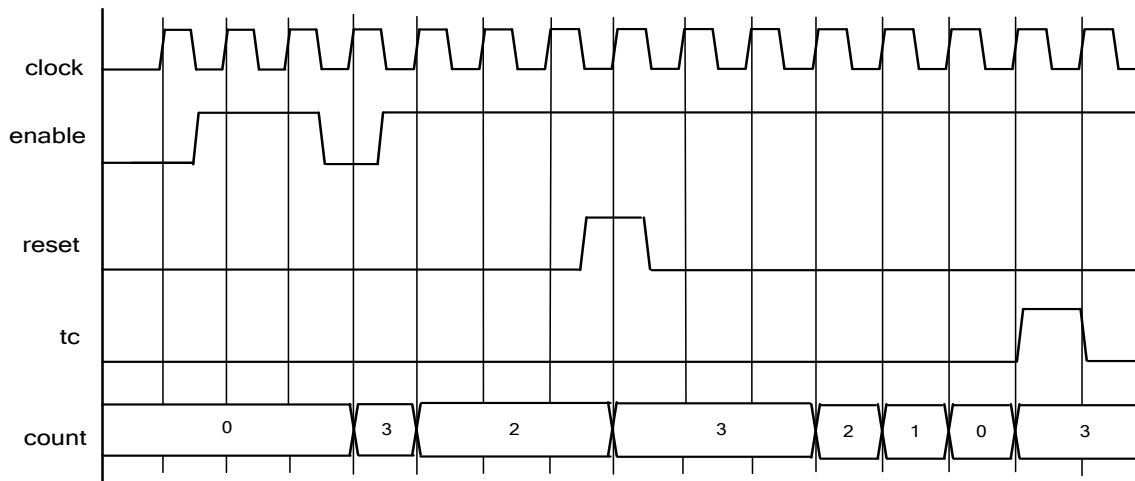
**Figure 9. One Shot Operation FF PSoC 3 Timer Implementation Example Waveform**

The functionality of the Timer when configured for One Shot operation with the FF implementation on PSoC 5 is shown in [Figure 10](#).

The terminal count signal is generated any time that the counter value is equal to zero with a one-clock-cycle lag. This occurs at initial configuration time. The TC signal stays high after a one shot period has been completed because the counter value stays at the value zero. The one exception to the generation of the TC signal when the counter is zero is that TC is always held at zero when the reset signal is active.

Once the One Shot period has completed, the Timer can be set up to run for another period by using a hardware reset. The hardware reset reloads the counter with zero and configures the Timer to run again. There is a one-cycle lag from releasing reset until the Timer is enabled to count down again.

**Note** One Shot mode with a hardware enable is not supported by the PSoC 5 FF configuration.

**Note** Because the TC signal is held low when the reset signal is active, two TC pulses are generated for each time the One Shot is run to completion. The first is when the counter counts to zero. The second is after the reset is removed, but before the counter has started counting. This is shown in the example waveform.

**Figure 10. One Shot Operation FF PSoC 5 Timer Implementation Example Waveform**

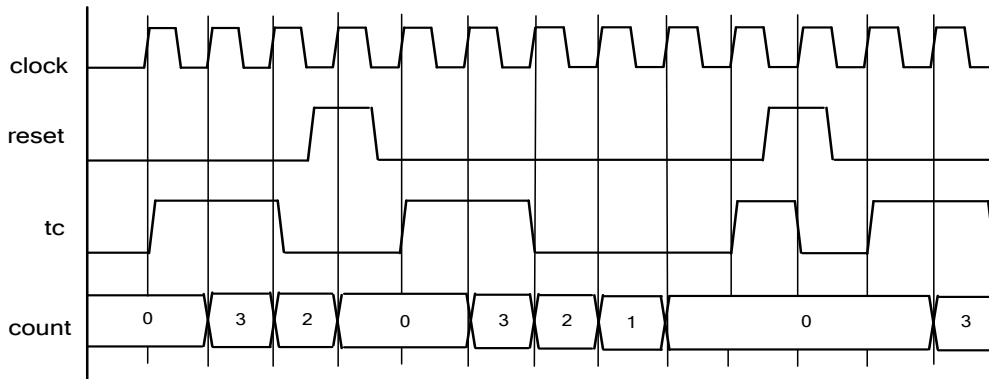

**UDB FIFOs**

The UDB datapath FIFOs are used to capture the counter value. Each FIFO is four bytes deep. For multi-byte configurations, each byte of the counter is captured simultaneously in the FIFO of the associated UDB. Therefore, up to four captures can be done before the CPU must read the capture register to avoid losing data.

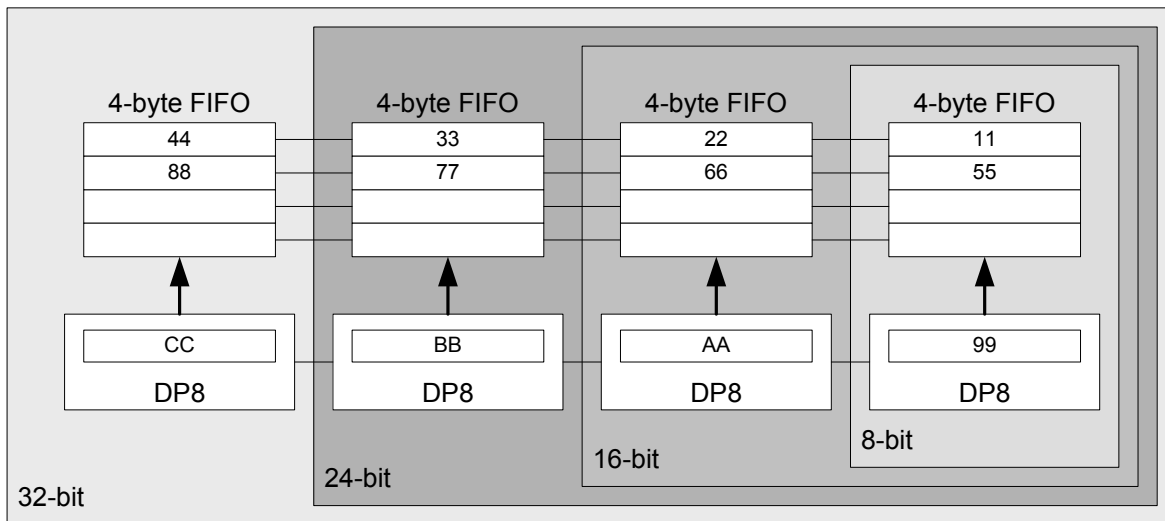

Capture Value #1 = 0x44332211  
 Capture Value #2 = 0x88776655  
 Accumulator = 0xCCBBAA99



## Registers

### Status Register

The status register is a read-only register that contains the status bits defined for the Timer. Use the `Timer_ReadStatusRegister()` function to read the status register value. All operations on the status register must use the following defines for the bit fields because these bit fields may be different between FF and UDB implementations.

Some bits in the status register are sticky, meaning that after they are set to 1, they retain that state until they are cleared when the register is read. The status data is registered at the input clock edge of the Timer, which gives all sticky bits the timing resolution of the Timer. All nonsticky bits are transparent and read directly from the inputs to the status register.

#### Timer\_Status (UDB Implementation)

| Bits   | 7    | 6    | 5    | 4    | 3              | 2         | 1       | 0    |
|--------|------|------|------|------|----------------|-----------|---------|------|
| Name   | RSVD | RSVD | RSVD | RSVD | FIFO Not Empty | FIFO Full | Capture | TC   |
| Sticky | N/A  | N/A  | N/A  | N/A  | FALSE          | FALSE     | TRUE    | TRUE |

#### Timer\_Status (Fixed Function Implementation)

| Bits   | 7    | 6       | 5    | 4    | 3    | 2    | 1    | 0    |
|--------|------|---------|------|------|------|------|------|------|
| Name   | TC   | Capture | RSVD | RSVD | RSVD | RSVD | RSVD | RSVD |
| Sticky | TRUE | TRUE    | N/A  | N/A  | N/A  | N/A  | N/A  | N/A  |

| Bit Name       | #define in header file             | Description                                                                                             |
|----------------|------------------------------------|---------------------------------------------------------------------------------------------------------|
| TC             | <code>Timer_STATUS_TC</code>       | This bit goes to 1 when the counter value is equal to zero.                                             |
| Capture        | <code>Timer_STATUS_CAPTURE</code>  | This bit goes to 1 whenever a valid capture event is triggered. This does not include software capture. |
| FIFO Full      | <code>Timer_STATUS_FIFOFULL</code> | This bit goes to 1 when the UDB FIFO reaches the full state defined as four entries.                    |
| FIFO Not Empty | <code>Timer_STATUS_FIFONEMP</code> | This bit goes to 1 when the UDB FIFO contains at least one entry.                                       |

## Mode Register

The mode register is a read/write register that contains the interrupt mask bits defined for the counter. Use the `Timer_SetInterruptMode()` function to set the mode bits. All operations on the mode register must use the following defines for the bit fields because these bit fields may be different between FF and UDB implementations.

The Timer component interrupt output is an OR function of all interrupt sources. Each source can be enabled or masked by the corresponding bit in the mode register.

### Timer\_Mode (UDB Implementation)

| Bits | 7    | 6    | 5    | 4    | 3    | 2         | 1       | 0  |
|------|------|------|------|------|------|-----------|---------|----|
| Name | RSVD | RSVD | RSVD | RSVD | RSVD | FIFO Full | Capture | TC |

### Timer\_Mode (Fixed-Function Implementation)

| Bits | 7    | 6    | 5    | 4    | 3  | 2       | 1    | 0    |
|------|------|------|------|------|----|---------|------|------|
| Name | RSVD | RSVD | RSVD | RSVD | TC | Capture | RSVD | RSVD |

| Bit Name  | #define in header file                      | Enables Interrupt Output On |
|-----------|---------------------------------------------|-----------------------------|
| TC        | <code>Timer_STATUS_TC_INT_MASK</code>       | Counter register equals 0   |
| Capture   | <code>Timer_STATUS_CAPTURE_INT_MASK</code>  | Capture                     |
| FIFO Full | <code>Timer_STATUS_FIFOFULL_INT_MASK</code> | UDB FIFO full               |

## Control Register

The Control register is used to control the general operation of the counter. This register is written with the `Counter_WriteControlRegister()` function call and read with the `Counter_ReadControlRegister()` function. All operations on the control register must use the following defines for the bit fields as these bit fields may be different between FF and UDB implementations.

**Note** When writing to the control register, you must not change any of the reserved bits. All operations must be read-modify-write with the reserved bits masked.

### Timer\_Control (UDB Implementation)

| Bits | 7      | 6                  | 5 | 4              | 3                  | 2 | 1                     | 0 |
|------|--------|--------------------|---|----------------|--------------------|---|-----------------------|---|
| Name | Enable | Capture Mode [1:0] |   | Trigger Enable | Trigger Mode [1:0] |   | Interrupt Count [1:0] |   |



**Timer\_Control1 (Fixed-Function Implementation)**

| Bits | 7    | 6    | 5    | 4    | 3    | 2    | 1    | 0      |
|------|------|------|------|------|------|------|------|--------|
| Name | RSVD | RSVD | RSVD | RSVD | RSVD | RSVD | RSVD | Enable |

| Bit Name        | #define in header file    | Description / Enumerated Type                                                                                                                                                                                                                                                                                                                                                                                                                                            |
|-----------------|---------------------------|--------------------------------------------------------------------------------------------------------------------------------------------------------------------------------------------------------------------------------------------------------------------------------------------------------------------------------------------------------------------------------------------------------------------------------------------------------------------------|
| Interrupt Count | Timer_CTRL_INTCNT_MASK    | The interrupt count bits define the number of capture events to count before an interrupt is fired.                                                                                                                                                                                                                                                                                                                                                                      |
| Trigger Mode    | Timer_CTRL_TRIG_MODE_MASK | The trigger mode control bits define the expected trigger input functionality. This bit field is configured at initialization with the trigger mode defined in the <b>Trigger Mode</b> parameter. <ul style="list-style-type: none"> <li>▪ Timer__B_TIMER__TM_NONE</li> <li>▪ Timer__B_TIMER__TM_RISINGEDGE</li> <li>▪ Timer__B_TIMER__TM_FALLINGEDGE</li> <li>▪ Timer__B_TIMER__TM_EITHEREDGE</li> <li>▪ Timer__B_TIMER__TM_SOFTWARE</li> </ul>                         |
| Trigger Enable  | Timer_CTRL_TRIG_EN        | The Trigger Enable bit allows for software control of when to prepare for a trigger event.                                                                                                                                                                                                                                                                                                                                                                               |
| Capture Mode    | Timer_CTRL_CAP_MODE_MASK  | The capture mode control bits are a two-bit field used to define the expected capture input operation. This bit field is configured at initialization with the capture mode defined in the <b>Capture Mode</b> parameter. <ul style="list-style-type: none"> <li>▪ Timer__B_TIMER__CM_NONE</li> <li>▪ Timer__B_TIMER__CM_RISINGEDGE</li> <li>▪ Timer__B_TIMER__CM_FALLINGEDGE</li> <li>▪ Timer__B_TIMER__CM_EITHEREDGE</li> <li>▪ Timer__B_TIMER__CM_SOFTWARE</li> </ul> |
| Enable          | Timer_CTRL_ENABLE         | Enables counting under software control. This bit is valid only if the <b>Enable Mode</b> parameter is set to <b>Software Only</b> or <b>Software and Hardware</b> .                                                                                                                                                                                                                                                                                                     |

**Counter (8-, 16-, 24-, or 32-bit Based on Resolution)**

The counter register contains the current counter value. This register is decremented in response to the rising edge of all clock inputs. This register may be read at any time with the `Timer_ReadCounter()` function call.

## Capture (8-, 16-, 24-, or 32-bit Based on Resolution)

The capture register contains the captured counter value. Any capture event copies the counter register to this register. In the UDB implementation, this register is actually a FIFO. See the [UDB FIFOs](#) section for details.

## Period (8-, 16-, 24-, or 32-bit Based on Resolution)

The period register contains the period value set with the `Timer_WritePeriod()` function call and defined by the **Period** parameter at initialization. The period register is copied into the counter register on a reload event.

## Component Debug Window

The Timer component supports the PSoC Creator component debug window. The following registers are displayed in the debug window. Some registers are available in the UDB implementation (indicated by \*) and some registers are only available in the fixed-function implementation (indicated by \*\*). All other registers are available for either configuration.

|                     |                                                                                                                                                                                                                                        |
|---------------------|----------------------------------------------------------------------------------------------------------------------------------------------------------------------------------------------------------------------------------------|
| <b>Register:</b>    | Timer_CONTROL                                                                                                                                                                                                                          |
| <b>Name:</b>        | Control Register                                                                                                                                                                                                                       |
| <b>Description:</b> | Refer to the Timer_Control register description earlier in this datasheet for bit-field definitions.                                                                                                                                   |
| <b>Register:</b>    | Timer_CONTROL2 **                                                                                                                                                                                                                      |
| <b>Name:</b>        | Fixed-Function Control Register #2                                                                                                                                                                                                     |
| <b>Description:</b> | The fixed-function Timer block has a second configuration register. Refer to the Technical Reference Manual for bit field definitions.                                                                                                 |
| <b>Register:</b>    | Timer_STATUS_MASK *                                                                                                                                                                                                                    |
| <b>Name:</b>        | Status Register Interrupt Mask Configuration                                                                                                                                                                                           |
| <b>Description:</b> | Allows you to enable any status bit as an interrupt source at the interrupt output pin of the component. Refer to the Timer_Status register description earlier in this datasheet for one-to-one correlation of bit-field definitions. |
| <b>Register:</b>    | Timer_STATUS_AUX_CTRL *                                                                                                                                                                                                                |
| <b>Name:</b>        | Auxiliary Control Register for the Status Register                                                                                                                                                                                     |
| <b>Description:</b> | Allows you to enable the interrupt output of the internal status register through the bit field INT_EN. Refer to the Technical Reference Manual for bit-field definitions.                                                             |



|                     |                                                                                                                          |
|---------------------|--------------------------------------------------------------------------------------------------------------------------|
| <b>Register:</b>    | Timer_PERIOD                                                                                                             |
| <b>Name:</b>        | Timer Period Register                                                                                                    |
| <b>Description:</b> | Defines the period value reloaded into the period counter at the beginning of each cycle of the Timer.                   |
| <b>Register:</b>    | Timer_COUNTER                                                                                                            |
| <b>Name:</b>        | Timer Counter Register                                                                                                   |
| <b>Description:</b> | Indicates the current counter value (in clock cycles from <b>Period</b> down to zero) of the current timer period cycle. |
| <b>Register:</b>    | Timer_GLOBAL_ENABLE **                                                                                                   |
| <b>Name:</b>        | Fixed Function Timer Global Enable Register                                                                              |
| <b>Description:</b> | Enables the Fixed-Function Timer for operation. Refer to the Technical Reference Manual for bit-field definitions.       |

## Resources

The Timer component is placed in the device based on the **Implementation** parameter. If it is set to **Fixed Function**, this component uses a FF counter/timer block. If it is set to **UDB**, the component uses the following resources.

| Configuration <sup>[1]</sup>                         | Resource Type  |            |              |               |              |            |
|------------------------------------------------------|----------------|------------|--------------|---------------|--------------|------------|
|                                                      | Datapath Cells | Macrocells | Status Cells | Control Cells | DMA Channels | Interrupts |
| 8-bit UDB Timer Trigger mode = Rising edge           | 1              | 6          | 1            | 1             | –            | –          |
| 16-bit UDB Timer Trigger mode = Rising edge          | 2              | 6          | 1            | 1             | –            | –          |
| 24-bit UDB Timer Trigger mode = Rising edge          | 3              | 6          | 1            | 1             | –            | –          |
| 32-bit UDB Timer Trigger mode = Rising edge          | 4              | 6          | 1            | 1             | –            | –          |
| 8-bit UDB Timer One Shot Trigger mode = Rising edge  | 1              | 9          | 1            | 1             | –            | –          |
| 16-bit UDB Timer One Shot Trigger mode = Rising edge | 2              | 9          | 1            | 1             | –            | –          |

1. For all configurations the common settings are: Enable mode = Software only, Capture mode = None, Interrupt = On TC



## API Memory Usage

The component memory usage varies significantly, depending on the compiler, device, number of APIs used and component configuration. The following table provides the memory usage for all APIs available in the given component configuration.

The measurements have been done with the associated compiler configured in Release mode with optimization set for Size. For a specific design the map file generated by the compiler can be analyzed to determine the memory usage.

| Configuration <sup>[2]</sup> | PSoC 3 (Keil_PK51) |            | PSoC 4 (GCC) |            | PSoC 5LP (GCC) |            |
|------------------------------|--------------------|------------|--------------|------------|----------------|------------|
|                              | Flash Bytes        | SRAM Bytes | Flash Bytes  | SRAM Bytes | Flash Bytes    | SRAM Bytes |
| 8-bit UDB Timer              | 255                | 5          | 396          | 5          | 444            | 5          |
| 8-bit FF Timer               | 234                | 2          | N/A          | N/A        | 366            | 5          |
| 16-bit UDB Timer             | 299                | 6          | 396          | 5          | 444            | 9          |
| 16-bit FF Timer              | 265                | 2          | N/A          | N/A        | 380            | 5          |
| 24-bit UDB Timer             | 287                | 8          | 412          | 5          | 452            | 13         |
| 32-bit UDB Timer             | 287                | 8          | 396          | 5          | 444            | 13         |
| 8-bit UDB Timer One Shot     | 255                | 5          | 396          | 5          | 444            | 5          |
| 16-bit UDB Timer One Shot    | 299                | 6          | 396          | 5          | 444            | 9          |

## DC and AC Electrical Characteristics PSoC 3 (FF Implementation)

Specifications are valid for  $-40\text{ }^{\circ}\text{C} \leq T_A \leq 85\text{ }^{\circ}\text{C}$  and  $T_J \leq 100\text{ }^{\circ}\text{C}$ , except where noted. Specifications are valid for 1.71 V to 5.5 V, except where noted.

### DC Characteristics

| Parameter | Description                            | Conditions                    | Min | Typ | Max | Units         |
|-----------|----------------------------------------|-------------------------------|-----|-----|-----|---------------|
|           | 16-bit timer block current consumption | Input clock frequency – 3 MHz | –   | 15  | –   | $\mu\text{A}$ |
|           |                                        | Input clock frequency –12 MHz | –   | 60  | –   | $\mu\text{A}$ |

2 For all configurations the common settings are: Enable mode = Software only, Capture mode = None, Interrupt = On TC



| Parameter | Description | Conditions                     | Min | Typ | Max | Units |
|-----------|-------------|--------------------------------|-----|-----|-----|-------|
|           |             | Input clock frequency – 48 MHz | –   | 260 | –   | μA    |
|           |             | Input clock frequency – 67 MHz | –   | 350 | –   | μA    |

## AC Characteristics

| Parameter | Description                    | Conditions | Min | Typ | Max   | Units |
|-----------|--------------------------------|------------|-----|-----|-------|-------|
|           | Operating frequency            |            | DC  | –   | 67.01 | MHz   |
|           | Capture pulse width (internal) |            | 15  | –   | –     | ns    |
|           | Capture pulse width (external) |            | 30  | –   | –     | ns    |
|           | Timer resolution               |            | 15  | –   | –     | ns    |
|           | Enable pulse width             |            | 15  | –   | –     | ns    |
|           | Enable pulse width (external)  |            | 30  | –   | –     | ns    |
|           | Reset pulse width              |            | 15  | –   | –     | ns    |
|           | Reset pulse width (external)   |            | 30  | –   | –     | ns    |

## DC and AC Electrical Characteristics for PSoC 5 (FF Implementation)

Specifications are valid for  $-40\text{ °C} \leq T_A \leq 85\text{ °C}$  and  $T_J \leq 100\text{ °C}$ , except where noted.  
Specifications are valid for 2.7 V to 5.5 V, except where noted.

### DC Characteristics

| Parameter | Description                            | Conditions                     | Min | Typ | Max | Units |
|-----------|----------------------------------------|--------------------------------|-----|-----|-----|-------|
|           | 16-bit timer block current consumption | Input clock frequency – 3 MHz  | –   | 65  | –   | μA    |
|           |                                        | Input clock frequency – 12 MHz | –   | 170 | –   | μA    |
|           |                                        | Input clock frequency – 48 MHz | –   | 650 | –   | μA    |
|           |                                        | Input clock frequency – 67 MHz | –   | 900 | –   | μA    |

### AC Characteristics

| Parameter | Description                    | Conditions | Min | Typ | Max   | Units |
|-----------|--------------------------------|------------|-----|-----|-------|-------|
|           | Operating frequency            |            | DC  | –   | 67.01 | MHz   |
|           | Capture pulse width (internal) |            | 13  | –   | –     | ns    |
|           | Capture pulse width (external) |            | 30  | –   | –     | ns    |



| Parameter | Description                   | Conditions | Min | Typ | Max | Units |
|-----------|-------------------------------|------------|-----|-----|-----|-------|
|           | Timer resolution              |            | 13  | –   | –   | ns    |
|           | Enable pulse width            |            | 13  | –   | –   | ns    |
|           | Enable pulse width (external) |            | 30  | –   | –   | ns    |
|           | Reset pulse width             |            | 13  | –   | –   | ns    |
|           | Reset pulse width (external)  |            | 30  | –   | –   | ns    |

## DC and AC Electrical Characteristics (UDB Implementation)

Specifications are valid for  $-40\text{ °C} \leq T_A \leq 85\text{ °C}$  and  $T_J \leq 100\text{ °C}$ , except where noted.  
 Specifications are valid for 1.71 V to 5.5 V, except where noted.

### DC Characteristics

| Parameter       | Description <sup>[1]</sup>                             | Min | Typ <sup>[2]</sup> | Max | Units  |
|-----------------|--------------------------------------------------------|-----|--------------------|-----|--------|
| I <sub>DD</sub> | Component current consumption                          |     |                    |     |        |
|                 | 8-bits UDB, Continuous, Trigger = None                 | –   | 6                  | –   | μA/MHz |
|                 | 8-bits UDB, One shot, Trigger = None                   | –   | 5                  | –   | μA/MHz |
|                 | 16-bits UDB, Continuous, Trigger = Rising edge         | –   | 8                  | –   | μA/MHz |
|                 | 16-bits UDB, One Shot, Trigger = Rising edge           | –   | 8                  | –   | μA/MHz |
|                 | 24-bits UDB, Continuous, Trigger = Either Edge         | –   | 10                 | –   | μA/MHz |
|                 | 32-bits UDB, Continuous, Trigger = Software Controlled | –   | 13                 | –   | μA/MHz |

- For all configurations the common settings are: Enable mode = Software only, Capture mode = None, Interrupt = On TC
- Device IO and clock distribution current not included. The values are at 25 °C.



## AC Characteristics

| Parameter          | Description <sup>[3]</sup>                             | Min | Typ | Max <sup>[4]</sup> | Units |
|--------------------|--------------------------------------------------------|-----|-----|--------------------|-------|
| f <sub>CLOCK</sub> | Component clock frequency                              |     |     |                    |       |
|                    | 8-bits UDB, Continuous, Trigger = None                 | –   | –   | 44                 | MHz   |
|                    | 8-bits UDB, One shot, Trigger = None                   | –   | –   | 44                 | MHz   |
|                    | 16-bits UDB, Continuous, Trigger = Rising edge         | –   | –   | 33                 | MHz   |
|                    | 16-bits UDB, One Shot, Trigger = Rising edge           | –   | –   | 33                 | MHz   |
|                    | 24-bits UDB, Continuous, Trigger = Either Edge         | –   | –   | 28                 | MHz   |
|                    | 32-bits UDB, Continuous, Trigger = Software Controlled | –   | –   | 25                 | MHz   |

3. For all configurations the common settings are: Enable mode = Software only, Capture mode = None, Interrupt = On TC

4. The values provide a maximum safe operating frequency of the component. The component may run at higher clock frequencies, at which point validation of the timing requirements with STA results is necessary.

## Component Changes

This section lists the major changes in the component from the previous version.

| Version | Description of Changes                                                                           | Reason for Changes / Impact                                                                                                                                                                                                                                         |
|---------|--------------------------------------------------------------------------------------------------|---------------------------------------------------------------------------------------------------------------------------------------------------------------------------------------------------------------------------------------------------------------------|
| 2.50    | Updated datasheet with memory usage for PSoC 4                                                   | Support for new device.                                                                                                                                                                                                                                             |
| 2.40    | Added MISRA Compliance section.                                                                  | The component does not have any specific deviations.                                                                                                                                                                                                                |
| 2.30    | Added PSoC 5LP support.                                                                          |                                                                                                                                                                                                                                                                     |
|         | Updated customizer to remove warning pop-up in One shot hardware enable mode.                    |                                                                                                                                                                                                                                                                     |
|         | Updated DC and AC Electrical characteristics.<br>Updated Resource and API memory usage sections. |                                                                                                                                                                                                                                                                     |
|         | Removed silicon revision enumerations from symbol file. Added description for formal parameters. |                                                                                                                                                                                                                                                                     |
| 2.20    | Verilog change for UDB implementation                                                            | To fix a case where the TC output could be missed under certain conditions when the hardware enable signal was being used                                                                                                                                           |
|         | Document that the interrupt signal is not available for PSoC 5 FF implementation                 | This feature was removed because it could not be supported by the silicon                                                                                                                                                                                           |
|         | Customizer updated to make Cancel button always available                                        | Under some error conditions the Cancel button had not been available                                                                                                                                                                                                |
|         | Extensive datasheet updates                                                                      | The implementation of the Timer is different for each of the implementations (UDB, PSoC 3 FF, PSoC 5 FF) and these differences were not adequately described. Particularly, see the waveforms provided in the Configurations section of the Functional Description. |
| 2.10    | Verilog update and customizer related updates                                                    | To fix a minor issue with Trigger logic and GUI related issues                                                                                                                                                                                                      |
|         | "Interrupt on Capture" is disabled when Capture Mode is set to None                              | "Interrupt on Capture" check box option was available even when Capture Mode is set to "None" and should not be made available                                                                                                                                      |
| 2.0     | Synchronized inputs                                                                              | All inputs are synchronized in the fixed-function implementation, at the input of the block.                                                                                                                                                                        |



| Version | Description of Changes                                                             | Reason for Changes / Impact                                                                                                                                                                                                      |
|---------|------------------------------------------------------------------------------------|----------------------------------------------------------------------------------------------------------------------------------------------------------------------------------------------------------------------------------|
|         | Timer_GetInterruptSource() function was converted to a Macro                       | The Timer_GetInterruptSource() function is exactly the same implementation as the Timer_ReadStatusRegister() function. To save code space this was converted to a macro substitution of the Timer_ReadStatusRegister() function. |
|         | Outputs are now registered to the component clock                                  | To avoid glitches on the outputs of the component it is required that all outputs be synchronized. This is done inside of the datapath when possible, to avoid excess resource use.                                              |
|         | Implemented critical regions when writing to Aux Control registers.                | CyEnterCriticalSection and CyExitCriticalSections functions are used when writing to Aux Control registers so that it is not modified by any other process thread.                                                               |
|         | Incorrect masking rectified while setting capture mode using SetCaptureMode() API. | Masking used for setting capture mode has erroneous value.                                                                                                                                                                       |
|         | Added characterization data to datasheet                                           |                                                                                                                                                                                                                                  |
|         | Minor datasheet edits and updates                                                  |                                                                                                                                                                                                                                  |

© Cypress Semiconductor Corporation, 2013. The information contained herein is subject to change without notice. Cypress Semiconductor Corporation assumes no responsibility for the use of any circuitry other than circuitry embodied in a Cypress product. Nor does it convey or imply any license under patent or other rights. Cypress products are not warranted nor intended to be used for medical, life support, life saving, critical control or safety applications, unless pursuant to an express written agreement with Cypress. Furthermore, Cypress does not authorize its products for use as critical components in life-support systems where a malfunction or failure may reasonably be expected to result in significant injury to the user. The inclusion of Cypress products in life-support systems application implies that the manufacturer assumes all risk of such use and in doing so indemnifies Cypress against all charges.

PSoC® is a registered trademark, and PSoC Creator™ and Programmable System-on-Chip™ are trademarks of Cypress Semiconductor Corp. All other trademarks or registered trademarks referenced herein are property of the respective corporations.

Any Source Code (software and/or firmware) is owned by Cypress Semiconductor Corporation (Cypress) and is protected by and subject to worldwide patent protection (United States and foreign), United States copyright laws and international treaty provisions. Cypress hereby grants to licensee a personal, non-exclusive, non-transferable license to copy, use, modify, create derivative works of, and compile the Cypress Source Code and derivative works for the sole purpose of creating custom software and or firmware in support of licensee product to be used only in conjunction with a Cypress integrated circuit as specified in the applicable agreement. Any reproduction, modification, translation, compilation, or representation of this Source Code except as specified above is prohibited without the express written permission of Cypress.

Disclaimer: CYPRESS MAKES NO WARRANTY OF ANY KIND, EXPRESS OR IMPLIED, WITH REGARD TO THIS MATERIAL, INCLUDING, BUT NOT LIMITED TO, THE IMPLIED WARRANTIES OF MERCHANTABILITY AND FITNESS FOR A PARTICULAR PURPOSE. Cypress reserves the right to make changes without further notice to the materials described herein. Cypress does not assume any liability arising out of the application or use of any product or circuit described herein. Cypress does not authorize its products for use as critical components in life-support systems where a malfunction or failure may reasonably be expected to result in significant injury to the user. The inclusion of Cypress' product in a life-support systems application implies that the manufacturer assumes all risk of such use and in doing so indemnifies Cypress against all charges.

Use may be limited by and subject to the applicable Cypress software license agreement.

