

# ADC Successive Approximation Register (ADC\_SAR)

1.90

## Features

- Supports PSoC 5 and PSoC 5LP devices
- 12-bit resolution at up to 1 msp/s maximum
- Four power modes
- Selectable resolution and sample rate
- Single-ended or differential input

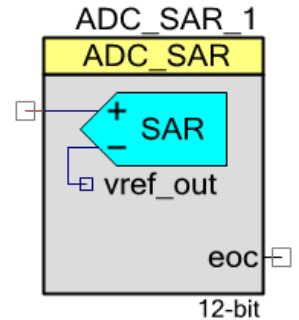

## General Description

The ADC Successive Approximation Register (ADC\_SAR) component provides medium-speed (maximum 1-mps sampling), medium-resolution (12 bits maximum), analog-to-digital conversion.

## When to Use an ADC\_SAR

Typical applications for the ADC\_SAR component include:

- LED lighting control
- Motor control
- Magnetic card reader
- High-speed data collection
- Power meter
- Pulse oximeter

## Input/Output Connections

This section describes the input and output connections for the ADC\_SAR. An asterisk (\*) in the list of I/Os indicates that the I/O may be hidden on the symbol under the conditions listed in the description of that I/O.

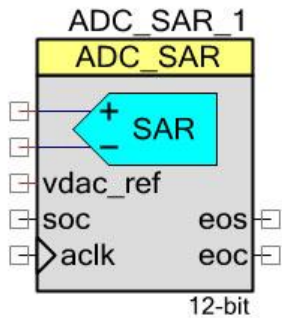

### +Input – Analog

This input is the positive analog signal input to the ADC\_SAR. The conversion result is a function of the +Input signal minus the voltage reference. The voltage reference is either the – Input signal or  $V_{SSA}$ .

### –Input – Analog \*

When shown, this optional input is the negative analog signal (or reference) input to the ADC\_SAR. The conversion result is a function of +Input minus –Input. You see this pin when you set the **Input Range** parameter to one of the differential modes.

### vdac\_ref – Input \*

The VDAC reference (vdac\_ref) is an optional pin. You see it if you have selected **Vssa to VDAC\*2 (Single Ended)** or **0.0 +/- VDAC (Differential)** input range; otherwise, this I/O is hidden. You can only connect this pin to a VDAC component output. Do not connect it to any other signal.

### soc – Input \*

The start of conversion (soc) is an optional pin. You see it if you select the **Triggered** sample mode. A rising edge on this input starts an ADC conversion. This signal should be synchronized to the ADC\_SAR clock. If you set the **Sample Mode** parameter to **Free Running**, this I/O is hidden.

## ack – Input \*

You can see this optional pin if you set the **Clock Source** parameter to **External**; otherwise, the pin is hidden. This clock determines the conversion rate as a function of conversion method and resolution.

## eos – Output \*

A rising edge on the end of sampling (eos) output indicates the completion of the sampling window. This signal can be used to control the input channel multiplexer. The input multiplexer selection can be changed after sampling is complete, but still during the conversion. The eos signal allows the SAR ADC to operate at its maximum speed. This output is visible if the **Enable EOS output** parameter is selected. This option is not available for the PSoC 5 device.

## eoc – Output

A rising edge on the end of conversion (eoc) output means that a conversion is complete. A DMA request can be connected to this pin to transfer the conversion output to system RAM, DFB, or other component. An internal interrupt is also connected to this signal, or you may connect your own interrupt.

## Component Parameters

Drag an ADC\_SAR component onto your design and double-click it to open the **Configure** dialog.

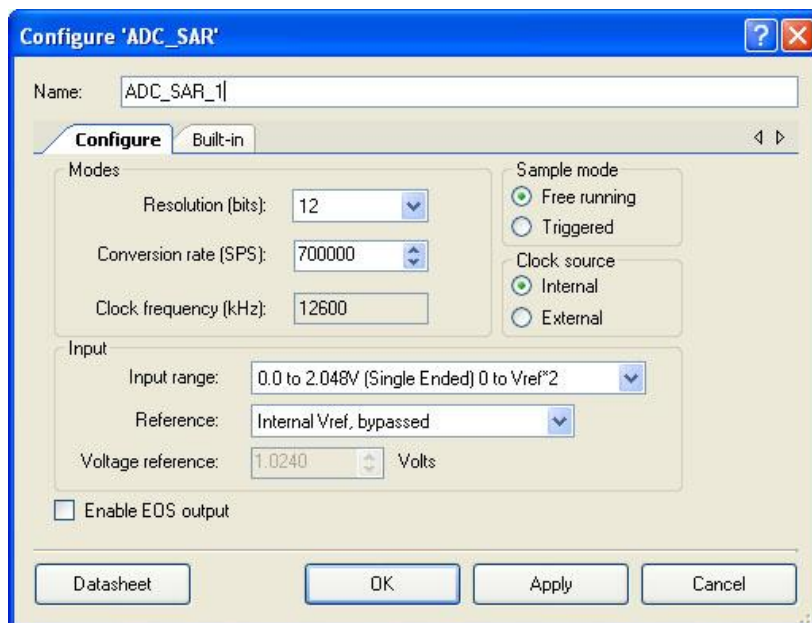

The ADC\_SAR has the following parameters. The option shown in bold is the default.



## Modes

### Resolution

Sets the resolution of the ADC.

ADC_Resolution	Value	Description
12	12	Sets resolution to 12 bits.
10	10	Sets resolution to 10 bits.
8	8	Sets resolution to 8 bits.

**Note** In PSoC 5 silicon, SAR always operates in 12-bit mode. The 8- and 10-bit options remain but only impact the ADC\_GetResult16() and ADC\_GetResult8() APIs.

### Conversion Rate

This parameter sets the ADC conversion. The conversion time is the inverse of the conversion rate. Enter the conversion rate in samples per second. Converting one sample takes 19 SAR ADC clock cycles in PSoC 5 silicon and 18 clock cycles in PSoC 5LP.

### Clock Frequency

This text box is a read-only (always grayed out) area that displays the required clock rate for the selected operating conditions: resolution and conversion rate. It is updated when either or both of these conditions change. Clock frequency can be anywhere between 1 MHz and 14 MHz (18 MHz in PSoC 5LP). The duty cycle should be 50 percent. The minimum pulse width should be greater than 33 ns (25.5 ns in PSoC 5LP). PSoC Creator will generate an error during the build process if the clock does not fall within these limits. In that case, change the Master Clock in the Design-Wide Resources Clock Editor.

At high conversation rates, the ADC can generate large amounts of data to process. In these cases, the data should either be collected using DMA or by using the CPU . If using the CPU, the CPU clock should be at a high clock rate and with a minimal interrupt service routine. For example, at a conversion rate of 700,000 samples per second and a CPU clock rate of 66 MHz, there are only  $66 \text{ MHz} / 700,000 \text{ sps} = 94$  CPU clock cycles per sample. Refer to the Interrupt Service Routine section for guidance on optimizing the ISR.

### Sample Mode

This parameter determines how the ADC operates.

Start_of_Conversion	Description
Free Running	ADC runs continuously.
Triggered	A rising-edge pulse on the SOC pin starts a single conversion.

## Clock Source

This parameter allows you to select either a clock that is internal to the ADC\_SAR module or an external clock.

ADC_Clock	Description
Internal	Use the internal clock of the ADC_SAR.
External	Use an external clock. The clock source can be analog, digital, or generated by another component.

## Input

### Input Range

This parameter configures the ADC for a given input range. The analog signals connected to the PSoC must be between  $V_{SSA}$  and  $V_{DDA}$  regardless of the input range settings.

Input Range	Description
0.0 to 2.048V (Single Ended) 0 to $V_{ref} \times 2$	When using the internal reference (1.024 V), the usable input range is 0.0 to 2.048 V. The ADC is configured to operate in a single-ended input mode with $-Input$ connected internally to $V_{refhi\_out}$ . If you are using an external reference voltage, the usable input range is 0.0 to $V_{ref} \times 2$ .
$V_{ssa}$ to $V_{dda}$ (Single Ended)	This mode uses the $V_{DDA}/2$ reference; the usable input range covers the full analog supply voltage. The ADC is put in a single-ended input mode with $-Input$ connected internally to $V_{refhi\_out}$ . If you are using an external reference voltage, the usable input range is 0.0 to $V_{ref} \times 2$ .
$V_{ssa}$ to $V_{DAC} \times 2$ (Single Ended)	This mode uses the $V_{DAC}$ reference, which should be connected to the $vdac\_ref$ pin. The usable input range is $V_{ssa}$ to $V_{DAC} \times 2$ volts. The ADC is configured to operate in a single-ended input mode with $-Input$ connected internally to $V_{refhi\_out}$ .
$0.0 \pm 1.024V$ (Differential) $-Input \pm V_{ref}$	This mode is configured for differential inputs. When using the internal reference (1.024 V), the input range is $-Input \pm 1.024 V$ .  For example, if $-Input$ is connected to 2.048 V, the usable input range is $2.048 \pm 1.024 V$ or 1.024 to 3.072 V. For systems in which both single-ended and differential signals are scanned, connect $-Input$ to $V_{ssa}$ when scanning a single-ended input.  You can use an external reference to provide a wider operating range. You can calculate the usable input range with the same equation, $-Input \pm V_{ref}$ .
$0.0 \pm V_{dda}$ (Differential) $-Input \pm V_{dda}$	This mode is configured for differential inputs and is ratiometric with the supply voltage. The input range is $-Input \pm V_{dda}$ . For systems in which both single-ended and differential signals are scanned, connect $-Input$ to $V_{ssa}$ when scanning a single-ended input. If you are using an external reference voltage, the usable input range is $-Input \pm V_{ref}$ .



Input Range	Description
0.0 ± Vdda/2 (Differential) –Input ± Vdda/2	This mode is configured for differential inputs and is ratiometric to the supply voltage. The input range is –Input ± Vdda/2. For systems in which both single-ended and differential signals are scanned, connect –Input to Vssa when scanning a single-ended input. If you are using an external reference voltage, the usable input range is –Input ± Vref.
0.0 ± VDAC (Differential) –Input ± VDAC	This mode is configured for differential inputs and uses the VDAC reference, which should be connected to the vdac_ref pin. The input range is –Input ±VDAC. For systems in which both single-ended and differential signals are scanned, connect –Input to Vssa when scanning a single-ended input.

## Reference

This parameter selects the switches for reference configuration for the ADC\_SAR.

ADC_Reference	Description
Internal Vref	Uses the internal reference. The maximum sampling rate allowed with this option is 100,000 sps, except of “0.0 ± Vdda” input range. Use the <b>Internal Vref, bypassed</b> option for higher rates.
<b>Internal Vref, bypassed</b>	Uses the internal reference; you must place a bypass capacitor on pin P0[2]* for SAR1 or on pin P0[4]* for SAR0. This mode is not applicable with “0.0 ± Vdda” input range.
External Vref	Uses an external reference on pin P0[2] for SAR1 or on pin P0[4] for SAR0.

\* The use of an external bypass capacitor is recommended if the internal noise caused by digital switching exceeds an application's analog performance requirements. To use this option, configure either port pin P0[2] or P0[4] as an analog HI-Z pin and connect an external capacitor with a value between 0.01 µF and 10 µF.

**Note** The same internal reference is used for ADC\_SAR and for ADC\_DeISig components. If both types of the ADC have to work with internal reference simultaneously, use the **Internal Vref, bypassed** option for the best performance.

## Voltage Reference

The voltage reference is used for the ADC count to voltage conversion functions discussed in the [Application Programming Interface](#) section. This parameter is read-only when using the internal reference. When using an external reference, you can edit this value to match the external reference voltage.

- When selecting input range **Vssa to Vdda**, **-Input +/- Vdda**, or **-Input +/- Vdda/2**, enter the V<sub>DDA</sub> supply voltage.
- When selecting the input range **Vssa to VDAC\*2** or **-Input +/- VDAC**, enter the VDAC supply voltage value.

**Note** The input range and reference voltage is limited by the V<sub>DDA</sub> voltage.



## Enable EOS output

This parameter enables the End-of-Sampling output.

## Application Programming Interface

Application Programming Interface (API) routines allow you to configure the component using software. The following table lists and describes the interface to each function. The subsequent sections discuss each function in more detail.

By default, PSoC Creator assigns the instance name “ADC\_SAR\_1” to the first instance of a component in a given design. You can rename the instance to any unique value that follows the syntactic rules for identifiers. The instance name becomes the prefix of every global function name, variable, and constant symbol. For readability, the instance name used in the following table is “ADC.”

Function	Description
ADC_Start()	Powers up the ADC and resets all states
ADC_Stop()	Stops ADC conversions and reduces the power to the minimum
ADC_SetPower()	Sets the power mode
ADC_SetResolution()	Sets the resolution of the ADC
ADC_StartConvert()	Starts conversions
ADC_StopConvert()	Stops conversions
ADC_IRQ_Enable()	An internal IRQ is connected to the eoc. This API enables the internal ISR.
ADC_IRQ_Disable()	An internal IRQ is connected to the eoc. This API disables the internal ISR.
ADC_IsEndConversion()	Returns a nonzero value if conversion is complete
ADC_GetResult8()	Returns a signed 8-bit conversion result
ADC_GetResult16()	Returns a signed 16-bit conversion result
ADC_SetOffset()	Sets the offset of the ADC
ADC_SetGain()	Sets the ADC gain in counts per volt
ADC_CountsTo_Volts()	Converts ADC counts to floating-point volts
ADC_CountsTo_mVolts()	Converts ADC counts to millivolts
ADC_CountsTo_uVolts()	Converts ADC counts to microvolts
ADC_Sleep()	Stops ADC operation and saves the user configuration
ADC_Wakeup()	Restores and enables the user configuration
ADC_Init()	Initializes the default configuration provided with the customizer
ADC_Enable()	Enables the clock and power for the ADC



Function	Description
ADC_SaveConfig()	Saves the current user configuration
ADC_RestoreConfig()	Restores the user configuration

## Global Variables

Variable	Description
ADC_initVar	This variable indicates whether the ADC has been initialized. The variable is initialized to 0 and set to 1 the first time ADC_Start() is called. This allows the component to restart without reinitialization after the first call to the ADC_Start() routine.  If reinitialization of the component is required, then the ADC_Init() function can be called before the ADC_Start() or ADC_Enable() functions.
ADC_offset	This variable calibrates the offset. It is set to 0 the first time ADC_Start() is called and can be modified using ADC_SetOffset(). The variable affects the ADC_CountsTo_Volts(), ADC_CountsTo_mVolts(), and ADC_CountsTo_uVolts() functions by subtracting the given offset.
ADC_countsPerVolt	This variable is used to calibrate the gain. It is calculated the first time ADC_Start() is called and each time ADC_SetResolution() is called. The value depends on resolution, input range, and voltage reference. It can be changed using ADC_SetGain().  This variable affects the ADC_CountsTo_Volts(), ADC_CountsTo_mVolts(), and ADC_CountsTo_uVolts() functions by supplying the correct conversion between ADC counts and the applied input voltage.
ADC_shift	In differential input mode the SAR ADC outputs digitally converted data in a binary offset scheme. This variable is used to convert the ADC counts to 2's complement form.  This variable is calculated the first time ADC_Start() is called and each time ADC_SetResolution() is called. The calculated value depends on the resolution and input mode.  This variable affects the ADC_GetResult8() and ADC_GetResult16() functions by subtracting the correct shift value.

## void ADC\_Start(void)

**Description:** This is the preferred method to begin component operation. ADC\_Start() sets the initVar variable, calls the ADC\_Init() function, and then calls the ADC\_Enable() function.

**Parameters:** None

**Return Value:** None

**Side Effects:** If the initVar variable is already set, this function only calls the ADC\_Enable() function.





**void ADC\_Stop(void)**

**Description:** Stops ADC conversions and reduces the power to the minimum.

**Note** This API does not power down the ADC, but reduces the power to the minimum. This device has a defect that causes connections to several analog resources to be unreliable when the device is not powered. The unreliability manifests itself in silent failures (for example, unpredictably bad results from analog components) when the component using that resource is stopped.

**Parameters:** None

**Return Value:** None

**Side Effects:** None

**void ADC\_SetPower(uint8 power)**

**Description:** Sets the operational power of the ADC. You should use the higher power settings with faster clock speeds.

**Parameters:** uint8 power: Power setting

Parameters Name	Value	Description	Clock Rate
ADC__HIGHPOWER	0	Normal power	14 MHz (18 MHz in PSoC 5 LP)
ADC__MEDPOWER	1	1/2 power	7 MHz (9 MHz in PSoC 5 LP)
ADC__LOWPOWER	2	1/3 power (1.25 power in PSoC 5 LP)	reserved
ADC__MINPOWER	3	1/4 power	3.5 MHz (4.5 MHz in PSoC 5 LP)

**Return Value:** None

**Side Effects:** The power setting may affect conversion accuracy.



**void ADC\_SetResolution(uint8 resolution)**

**Description:** Sets the resolution for the GetResult16() and GetResult8() APIs. This function does not affect the actual conversion in PSoC 5 silicon.

**Parameters:** uint8 resolution: Resolution setting

Parameters Name	Value	Description
ADC__BITS_12	12	Sets resolution to 12 bits.
ADC__BITS_10	10	Sets resolution to 10 bits.
ADC__BITS_8	8	Sets resolution to 8 bits.

**Return Value:** None

**Side Effects:** The ADC resolution cannot be changed during a conversion cycle. The recommended best practice is to stop conversions with ADC\_StopConvert(), change the resolution, then restart the conversions with ADC\_StartConvert().

If you decide not to stop conversions before calling this API, use ADC\_IsEndConversion() to wait until conversion is complete before changing the resolution.

If you call ADC\_SetResolution() during a conversion, the resolution will not change until the current conversion is complete. Data will not be available in the new resolution for another 6 + "New Resolution(in bits)" clock cycles. You may need add a delay of this number of clock cycles after ADC\_SetResolution() is called before data is valid again.

Affects ADC\_CountsTo\_Volts(), ADC\_CountsTo\_mVolts(), and ADC\_CountsTo\_uVolts() by calculating the correct conversion between ADC counts and the applied input voltage. Calculation depends on resolution, input range, and voltage reference.

**void ADC\_StartConvert(void)**

**Description:** Forces the ADC to initiate a conversion. In free-running mode, the ADC runs continuously. In triggered mode, the function also acts as a software version of the SOC and every conversion must be triggered by ADC\_StartConvert().

**Parameters:** None

**Return Value:** None

**Side Effects:** Calling ADC\_StartConvert() disables the external SOC pin.

**void ADC\_StopConvert(void)**

**Description:** Forces the ADC to stop conversions. If a conversion is currently executing, that conversion will complete, but no further conversions will occur.

**Parameters:** None

**Return Value:** None

**Side Effects:** In triggered mode, this function sets a software version of the SOC to low level and switches the SOC source to hardware SOC input.



### void ADC\_IRQ\_Enable(void)

- Description:** Enables interrupts to occur at the end of a conversion. Global interrupts must also be enabled for the ADC interrupts to occur. To enable global interrupts, call the enable global interrupt macro “CYGlobalIntEnable;” in your *main.c* file before enabling any interrupts.
- Parameters:** None
- Return Value:** None
- Side Effects:** Enables interrupts to occur. Reading the result clears the interrupt.

### void ADC\_IRQ\_Disable(void)

- Description:** Disables interrupts at the end of a conversion.
- Parameters:** None
- Return Value:** None
- Side Effects:** None

### uint8 ADC\_IsEndConversion(uint8 retMode)

- Description:** Immediately returns the status of the conversion or does not return (blocking) until the conversion completes, depending on the retMode parameter.
- Parameters:** uint8 retMode: Check conversion return mode. See the following table for options.

Options	Description
ADC_RETURN_STATUS	Immediately returns the status. If the value returned is zero, the conversion is not complete, and this function should be retried until a nonzero result is returned.
ADC_WAIT_FOR_RESULT	Does not return a result until the ADC conversion is complete.

- Return Value:** uint8: If a nonzero value is returned, the last conversion is complete. If the returned value is zero, the ADC is still calculating the last result.
- Side Effects:** This function reads the end of conversion status, which is cleared on read.



## int8 ADC\_GetResult8(void)

- Description:** Returns the result of an 8-bit conversion. If the resolution is set greater than 8 bits, the function returns the LSB of the result. In PSoC 5 this function returns a shifted value when the resolution is set to less than 12 bits. ADC\_IsEndConversion() should be called to verify that the data sample is ready.
- Parameters:** None
- Return Value:** int8: The LSB of the last ADC conversion.
- Side Effects:** Converts the ADC counts to the 2's complement form.

## int16 ADC\_GetResult16(void)

- Description:** Returns a 16-bit result for a conversion with a result that has a resolution of 8 to 12 bits. In PSoC 5 this function returns a shifted value when the resolution is set to less than 12 bits. ADC\_IsEndConversion() should be called to verify that the data sample is ready.
- Parameters:** None
- Return Value:** int16: The 16-bit result of the last ADC conversion
- Side Effects:** Converts the ADC counts to the 2's complement form.

## void ADC\_SetOffset(int16 offset)

- Description:** Sets the ADC offset, which is used by ADC\_CountsTo\_Volts(), ADC\_CountsTo\_mVolts(), and ADC\_CountsTo\_uVolts(), to subtract the offset from the given reading before calculating the voltage conversion.
- Parameters:** int16 offset: This value is measured when the inputs are shorted or connected to the same input voltage.
- Return Value:** None
- Side Effects:** Affects ADC\_CountsTo\_Volts(), ADC\_CountsTo\_mVolts(), and ADC\_CountsTo\_uVolts() by subtracting the given offset.

## void ADC\_SetGain(int16 adcGain)

- Description:** Sets the ADC gain in counts per volt for the voltage conversion functions that follow. This value is set by default by the reference and input range settings. It should only be used to further calibrate the ADC with a known input or if the ADC is using an external reference.
- Parameters:** int16 adcGain: ADC gain in counts per volt
- Return Value:** None
- Side Effects:** Affects ADC\_CountsTo\_Volts(), ADC\_CountsTo\_mVolts(), ADC\_CountsTo\_uVolts() by supplying the correct conversion between ADC counts and the applied input voltage.

## float ADC\_CountsTo\_Volts(int16 adcCounts)

- Description:** Converts the ADC output to volts as a floating-point number. For example, if the ADC measured 0.534 volts, the return value would be 0.534.
- Parameters:** int16 adcCounts: Result from the ADC conversion
- Return Value:** Float: Result in volts
- Side Effects:** None

## int16 ADC\_CountsTo\_mVolts(int16 adcCounts)

- Description:** Converts the ADC output to millivolts as a 16-bit integer. For example, if the ADC measured 0.534 volts, the return value would be 534.
- Parameters:** int16 adcCounts: Result from the ADC conversion
- Return Value:** int16: Result in mV
- Side Effects:** None

## int32 ADC\_CountsTo\_uVolts(int16 adcCounts)

- Description:** Converts the ADC output to microvolts as a 32-bit integer. For example, if the ADC measured 0.534 volts, the return value would be 534000.
- Parameters:** int16 adcCounts: Result from the ADC conversion
- Return Value:** int32: Result in  $\mu$ V
- Side Effects:** None

## void ADC\_Sleep(void)

- Description:** This is the preferred routine to prepare the component for sleep. The ADC\_Sleep() routine saves the current component state. Then it calls the ADC\_Stop() function and calls ADC\_SaveConfig() to save the hardware configuration.
- Call the ADC\_Sleep() function before calling the CyPmSleep() or the CyPmHibernate() function. See the PSoC Creator *System Reference Guide* for more information about power-management functions.
- Parameters:** None
- Return Value:** None
- Side Effects:** None



## void ADC\_Wakeup(void)

**Description:** This is the preferred routine to restore the component to the state when ADC\_Sleep() was called. The ADC\_Wakeup() function calls the ADC\_RestoreConfig() function to restore the configuration. If the component was enabled before the ADC\_Sleep() function was called, the ADC\_Wakeup() function also re-enables the component.

**Parameters:** None

**Return Value:** None

**Side Effects:** Calling the ADC\_Wakeup() function without first calling the ADC\_Sleep() or ADC\_SaveConfig() function can produce unexpected behavior.

## void ADC\_Init(void)

**Description:** Initializes or restores the component according to the customizer Configure dialog settings. It is not necessary to call ADC\_Init() because the ADC\_Start() routine calls this function and is the preferred method to begin component operation.

**Parameters:** None

**Return Value:** None

**Side Effects:** All registers will be set to values according to the customizer Configure dialog.

## void ADC\_Enable(void)

**Description:** Activates the hardware and begins component operation. The higher power is set automatically depending on clock speed. The ADC\_SetPower() API description contains the relation of the power from the clock rate. It is not necessary to call ADC\_Enable() because the ADC\_Start() routine calls this function, which is the preferred method to begin component operation.

**Parameters:** None

**Return Value:** None

**Side Effects:** None



### void ADC\_SaveConfig(void)

- Description:** This function saves the component configuration and nonretention registers. It also saves the current component parameter values, as defined in the Configure dialog or as modified by the appropriate APIs. This function is called by the ADC\_Sleep() function.
- Parameters:** None
- Return Value:** None
- Side Effects:** All ADC configuration registers are retained. This function does not have an implementation and is meant for future use. It is provided here so that the APIs are consistent across components.

### void ADC\_RestoreConfig(void)

- Description:** This function restores the component configuration and nonretention registers. It also restores the component parameter values to what they were before calling the ADC\_Sleep() function.
- Parameters:** None
- Return Value:** None
- Side Effects:** Calling this function without first calling the ADC\_Sleep() or ADC\_SaveConfig() function can produce unexpected behavior. This function does not have an implementation and is meant for future use. It is provided here so that the APIs are consistent across components.

## DMA

You can use the DMA component to transfer converted results from ADC\_SAR register to RAM. You should connect the DMA data request signal (DRQ) to the EOC pin from the ADC. You can use the DMA Wizard to configure DMA operation as follows:

Name of DMA Source	Length	Direction	DMA Request Signal	DMA Request Type	Description
ADC_SAR_WRK0_PTR	2	Source	EOF	Rising Edge	Receive a 2-byte result for a conversion with a result that always has 12-bit resolution.  Note that this register is not sign extended; the result is always unsigned. A 0-V differential input returns a half-scale code. A full negative input returns a 0 code, and a full positive input returns a full-scale code.



## Sample Firmware Source Code

PSoC Creator provides many example projects that include schematics and example code in the Find Example Project dialog. For component-specific examples, open the dialog from the Component Catalog or an instance of the component in a schematic. For general examples, open the dialog from the Start Page or **File** menu. As needed, use the **Filter Options** in the dialog to narrow the list of projects available to select.

Refer to the “Find Example Project” topic in the PSoC Creator Help for more information.

## Interrupt Service Routine

The ADC\_SAR contains a blank interrupt service routine in the file *ADC\_SAR\_1\_INT.c* file, where “ADC\_SAR\_1” is the instance name. You can place custom code in the designated areas to perform whatever function is required at the end of a conversion. A copy of the blank interrupt service routine is shown below. Place custom code between the “/\* `#START MAIN\_ADC\_ISR` \*/” and “/\* `#END` \*/” comments. This ensures that the code will be preserved when a project is regenerated.

```
CY_ISR( ADC_SAR_1_ISR )
{
    /* Place user ADC ISR code here. This can be a good place */
    /* to place code that is used to switch the input to the */
    /* ADC. It may be good practice to first stop the ADC */
    /* before switching the input then restart the ADC. */

    /* `#START MAIN_ADC_ISR` */
    /* Place user code here. */
    /* `#END` */
}
```

A second designated area is available to place variable definitions and constant definitions.

```
/* System variables */

/* `#START ADC_SYS_VAR` */
/* Place user code here. */
/* `#END` */
```

An example of code that uses an interrupt to capture data follows.

```
#include <device.h>

int16 result = 0;
uint8 dataReady = 0;
void main()
{
    int16 newReading = 0;
    CYGlobalIntEnable;           /* Enable Global interrupts */
    ADC_SAR_1_Start();           /* Initialize ADC */
    ADC_SAR_1_IRQ_Enable();      /* Enable ADC interrupts */
```





```

ADC_SAR_1_StartConvert();    /* Start ADC conversions */
for(;;)
{
    if (dataReady != 0)
    {
        dataReady = 0;
        newReading = result;
        /* More user code */
    }
}
}

```

### Interrupt code segments in the file *ADC\_SAR\_1\_INT.c*.

```

/*****
*      System variables
*****/
/* `#START ADC_SYS_VAR` */
extern int16 result;
extern uint8 dataReady;
/* `#END` */

CY_ISR(ADC_SAR_1_ISR )
{
    /*****/
    /* Place user ADC ISR code here.          */
    /* This can be a good place to place code */
    /* that is used to switch the input to the */
    /* ADC. It may be good practice to first  */
    /* stop the ADC before switching the input */
    /* then restart the ADC.                  */
    /*****/
    /* `#START MAIN_ADC_ISR` */
    result = ADC_SAR_1_GetResult16();
    dataReady = 1;
    /* `#END` */
}

```

It is important to set the Conversion Rate and Master Clock parameters correctly.

For example, at the maximum conversion rate (700 ksp/s at 12 bits) set the Master Clock to 53 MHz in the Design-Wide Resources Clock Editor, and optimize the ISR routine. Otherwise, the processor will not be able to handle the ISR quickly enough. If you select a lower Master Clock, the run time of the ISR will be longer than ADC\_SAR conversion time.

You can optimize the ISR by reading sample registers directly:

```

CY_ISR(ADC_SAR_1_ISR )
{
    /*****/
    /* Place user ADC ISR code here.          */
    /* This can be a good place to place code */
    /* that is used to switch the input to the */
    /* ADC. It may be good practice to first  */

```



```

/* stop the ADC before switching the input */
/* then restart the ADC. */
/*****/
/* `#START MAIN_ADC_ISR` */
    result = CY_GET_REG16(ADC_SAR_1_SAR_WRK0_PTR);
    dataReady = 1;
/* `#END` */
}

```

## Functional Description

The following figure shows a block diagram. An input analog signal is sampled and compared with the output of a DAC using a binary search algorithm to determine the conversion bits in succession from MSB to LSB.

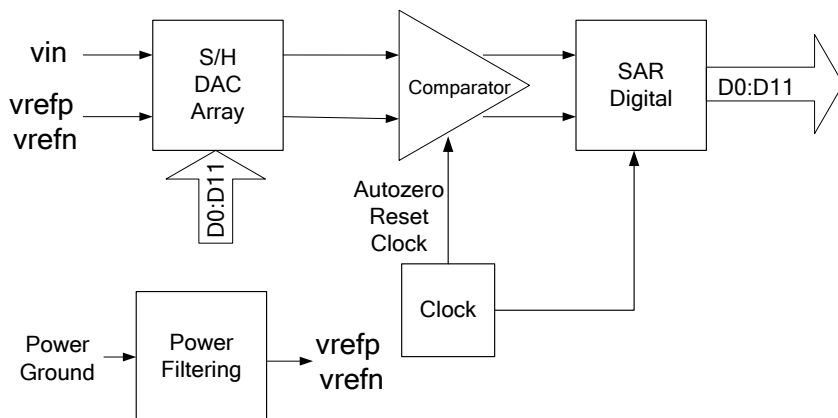

# Registers

## Sample Registers

The ADC results can be between 8 and 12 bits of resolution. The output is divided into two 8-bit registers. The CPU or DMA can access these registers to read the ADC result.

### ADC\_SAR\_WRK0\_REG (SAR working register 0)

Bits	7	6	5	4	3	2	1	0
Value	Data[7:0]							

### ADC\_SAR\_WRK1\_REG (SAR working register 1)

Bits	7	6	5	4	3	2	1	0
Value	overrun_det	N/A			Data[11:8]			

- Data[11:0]: The ADC results
- overrun\_det: Data overrun detection flag. This function is disabled by default.

## Resources

The ADC\_SAR uses a fixed-block SAR in the silicon.

## API Memory Usage

The component memory usage varies significantly, depending on the compiler, device, number of APIs used and component configuration. The following table provides the memory usage for all APIs available in the default component configuration.

The measurements have been done with the associated compiler configured in Release mode with optimization set for Size. For a specific design the map file generated by the compiler can be analyzed to determine the memory usage.

Configuration	PSoC 3 (Keil_PK51)		PSoC 5 (GCC)		PSoC 5LP (GCC)	
	Flash Bytes	SRAM Bytes	Flash Bytes	SRAM Bytes	Flash Bytes	SRAM Bytes
Default	N/A	N/A	854	13	794	11



## DC and AC Electrical Characteristics

The following values indicate performance for PSoC 5. These values can be used as preliminary performance expectations for PSoC 5LP prior to final characterization. Unless otherwise specified, operating conditions are:

- Operation in continuous sample mode
- Fclk = 14 MHz
- Input range =  $\pm V_{REF}$
- Bypass capacitor of 10  $\mu$ F

### DC Specifications

Parameter	Description	Conditions	Min	Typ	Max	Units
	Resolution		8	–	12	bits
	Number of channels – single-ended		–	–	No. of GPIO	–
	Number of channels – differential	Differential pair is formed using a pair of GPIOs.	–	–	No. of GPIO/2	–
	Monotonicity <sup>1</sup>		Yes	–	–	
Ge	Gain error	External reference	–	–	$\pm 0.2$	%
V <sub>os</sub>	Input offset voltage	V <sub>CM</sub> = 0 V	–	–	$\pm 2$	mV
		V <sub>CM</sub> = V <sub>DD</sub> /2	–	–	$\pm 6$	
I <sub>DD</sub>	Current consumption		–	–	1	mA
	Input voltage range – single-ended <sup>1</sup>		V <sub>SSA</sub>	–	V <sub>DDA</sub>	V
	Input voltage range – differential <sup>1</sup>		V <sub>SSA</sub>	–	V <sub>DDA</sub>	V
	External reference input voltage range		0.8	–	V <sub>DDA</sub>	V
PSRR	Power supply rejection ratio <sup>1</sup>		70	–	–	dB
CMRR	Common mode rejection ratio		35	–	–	dB
INL	Integral nonlinearity <sup>1</sup>	Internal reference from V <sub>BG</sub>	–	–	$\pm 2$	LSB
DNL	Differential nonlinearity <sup>1</sup>	Internal reference from V <sub>BG</sub>	–	–	$\pm 2$	LSB

<sup>1</sup> Based on device characterization (not production tested).

**DNL vs Output Code,  
Bypassed Internal Reference Mode**

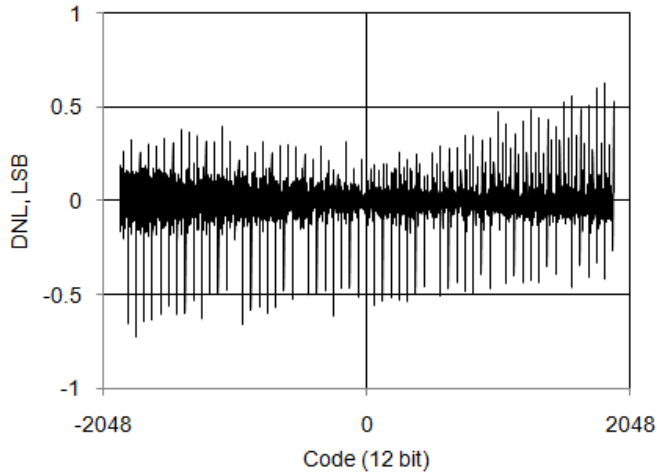

**INL vs Output Code,  
Bypassed Internal Reference Mode**

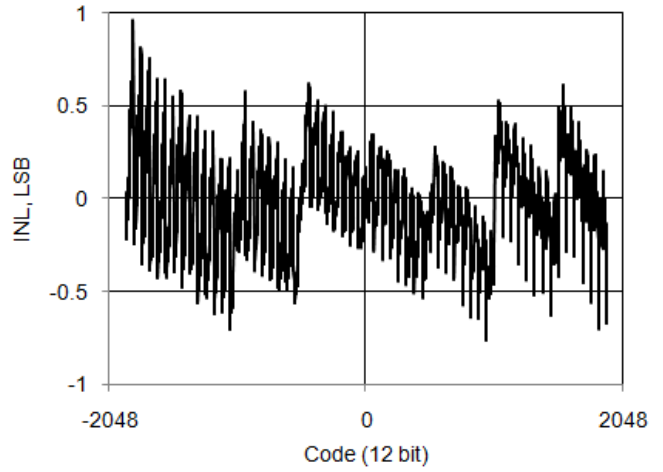

**IDD vs sps, VDDA = 5 V, Continuous Sample Mode,  
External Reference Mode**

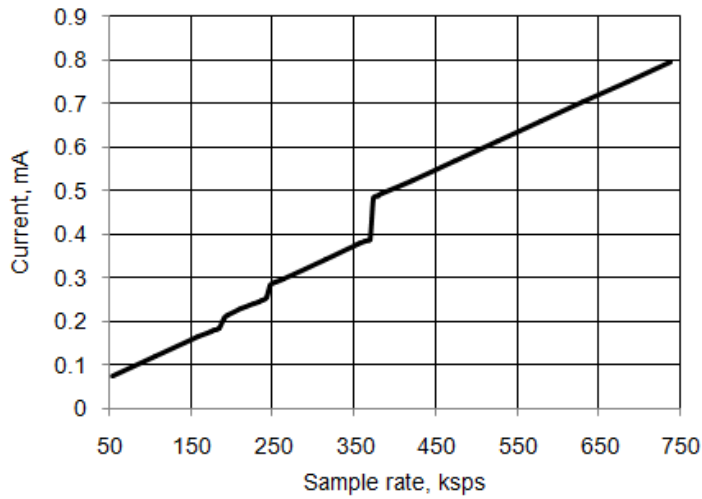

## AC Specifications

Parameter	Description	Conditions	Min	Typ	Max	Units
	Sample rate <sup>2</sup>	PSoC 5LP with bypass capacitor	–	–	1000	ksps
		PSoC 5 with bypass capacitor	–	–	736	
		Without bypass capacitor	–	–	100	
	Startup time <sup>2</sup>		–	–	10	μs
SINAD	Signal-to-noise ratio <sup>2</sup>	$V_{DDA} \leq 3.6 \text{ V}, V_{REF} \leq 3.6 \text{ V}$	57	–	–	dB
		$3.6 \text{ V} < V_{DDA} \leq 5.5 \text{ V}$ $V_{REF} < 1.3 \text{ V}$ or $V_{REF} > 1.8 \text{ V}$	57	–	–	
THD	Total harmonic distortion <sup>2</sup>	$V_{DDA} \leq 3.6 \text{ V}, V_{REF} \leq 3.6 \text{ V}$	–	–	0.1	%
		$3.6 \text{ V} < V_{DDA} \leq 5.5 \text{ V}$ $V_{REF} < 1.3 \text{ V}$ or $V_{REF} > 1.8 \text{ V}$	–	–	0.1	

<sup>2</sup> Based on device characterization (not production tested).

**Noise Histogram, 1000 samples, 700 ksps,  
Internal Reference No Bypass,  $V_{IN} = V_{REF}/2$**

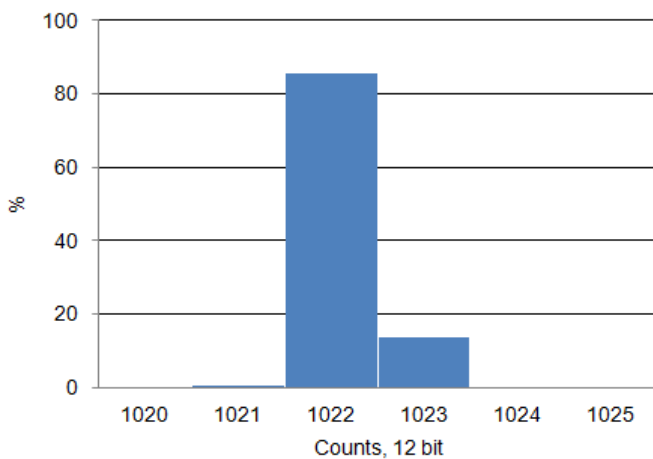

**Noise Histogram, 1000 samples, 700 ksps,  
Internal Reference Bypassed,  $V_{IN} = V_{REF}/2$**

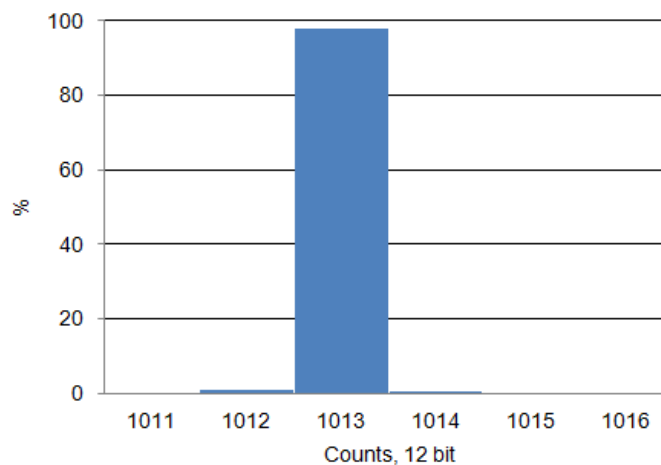

**Noise Histogram, 1000 samples,  
700 ksps, External Reference, VIN = VREF/2**

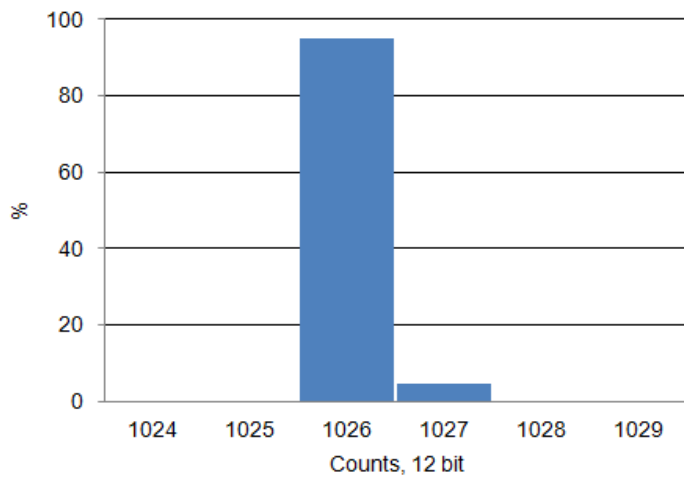

## Component Changes

This section lists the major changes in the component from the previous version.

Version	Description of Changes	Reason for Changes / Impact
1.90.a	Minor datasheet edit.	
1.90	Added optional EOS output.	This signal is useful when the SAR ADC is used along with an input channel multiplexer, to switch the multiplexer as soon as possible.
	Hid the "Internal Vref, bypassed" item from the reference drop-down list when "0.0 ± Vdda" is selected as the input range. A high conversion rate is allowed for this range without the bypass capacitor.	The bypass capacitor is not needed for Vdda reference.
1.80	Added support for PSoC 5LP silicon.	
	Edited the datasheet to clarify clock frequency.	
1.71	Fixed the ADC_GetResult8() and ADC_GetResult16() APIs to perform one 16-bit read operation instead of two 8-bit reads.	The resulting data can be corrupted if the SAR ADC updates the output sampling register after one of the bytes has been read.
	Fixed the ADC_IsEndConversion() API to wait until the EOF status bit is released.	This function can return an unexpected Conversion complete status after quick consecutive calls.
1.70	Corrected minimum value in SampleRate error provider message.	
	Hid the "External Vref" item from the Reference drop-down list when "VDAC" is selected as Input Range.	External reference is not usable when VDAC range is selected.
	Renamed the external pin to "ExtVref" when the External Vref option is chosen. The name "Bypass" is retained when Internal reference with Bypass option is chosen.	To match the pin name with functionality.
	Datasheet corrections	
1.60	Removed the "Power" parameter from the customizer.	The higher power is set automatically depending on clock speed. The ADC_SetPower() API description contains the relation of the power from the clock rate.
	SAR operates in 12-bit mode. The 8 and 10 bit options remain but only impact the ADC_GetResult16() API.	SAR ADC only showed ODD counts as output in 8- or 10-bit Mode.
	Changed default SAR conversion rate from 1 Msps to 631579 sps (12-MHz clock).	The SAR should be able to place and build with default settings.



Version	Description of Changes	Reason for Changes / Impact
	The ADC_Stop() API does not power down the ADC, but reduces the power to the minimum.	PSoC 5 silicon has a defect that causes connections to several analog resources to be unreliable when not powered.
	Changed the conversion time from 18 to 19 cycles.	To improve the SAR performance.
1.50.a	Added Clock Frequency verification.	This change provides a way to avoid using the SAR ADC with an out of spec clock. If updating from version 1.10 of the SAR ADC component and using an out of working range clock, select a correct clock frequency.
	Added information to the component that advertizes its compatibility with silicon revisions.	The tool reports an error/warning if the component is used on incompatible silicon. If this happens, update to a revision that supports your target device.
	Minor datasheet edits and updates	
1.50	Added Sleep/Wakeup and Init/Enable APIs.	To support low-power modes and to provide common interfaces to separate control of initialization and enabling of most components.
	Added ADC_CountsTo_Volts and ADC_CountsTo_uVolts APIs.	Extend functionality. This APIs returns the converted result in Volts and uVolts.
	Added the DMA Capabilities file to the component.	This file allows the ADC_SAR to be supported by the DMA Wizard tool in PSoC Creator.
	Implemented conversion of the ADC counts to the 2's complement form in the ADC_GetResult8 and ADC_GetResult16 APIs. The same was removed from the ADC_CountsTo_mVolts function.	This change has been done for consistency with the ADC DelSig.

© Cypress Semiconductor Corporation, 2012-2015. The information contained herein is subject to change without notice. Cypress Semiconductor Corporation assumes no responsibility for the use of any circuitry other than circuitry embodied in a Cypress product. Nor does it convey or imply any license under patent or other rights. Cypress products are not warranted nor intended to be used for medical, life support, life saving, critical control or safety applications, unless pursuant to an express written agreement with Cypress. Furthermore, Cypress does not authorize its products for use as critical components in life-support systems where a malfunction or failure may reasonably be expected to result in significant injury to the user. The inclusion of Cypress products in life-support systems application implies that the manufacturer assumes all risk of such use and in doing so indemnifies Cypress against all charges.

PSoC® is a registered trademark, and PSoC Creator™ and Programmable System-on-Chip™ are trademarks of Cypress Semiconductor Corp. All other trademarks or registered trademarks referenced herein are property of the respective corporations.

Any Source Code (software and/or firmware) is owned by Cypress Semiconductor Corporation (Cypress) and is protected by and subject to worldwide patent protection (United States and foreign), United States copyright laws and international treaty provisions. Cypress hereby grants to licensee a personal, non-exclusive, non-transferable license to copy, use, modify, create derivative works of, and compile the Cypress Source Code and derivative works for the sole purpose of creating custom software and/or firmware in support of licensee product to be used only in conjunction with a Cypress integrated circuit as specified in the applicable agreement. Any reproduction, modification, translation, compilation, or representation of this Source Code except as specified above is prohibited without the express written permission of Cypress.

Disclaimer: CYPRESS MAKES NO WARRANTY OF ANY KIND, EXPRESS OR IMPLIED, WITH REGARD TO THIS MATERIAL, INCLUDING, BUT NOT LIMITED TO, THE IMPLIED WARRANTIES OF MERCHANTABILITY AND FITNESS FOR A PARTICULAR PURPOSE. Cypress reserves the right to make changes without further notice to the materials described herein. Cypress does not assume any liability arising out of the application or use of any product or circuit described herein. Cypress does not authorize its products for use as critical components in life-support systems where a malfunction or failure may reasonably be expected to result in significant injury to the user. The inclusion of Cypress' product in a life-support systems application implies that the manufacturer assumes all risk of such use and in doing so indemnifies Cypress against all charges.

Use may be limited by and subject to the applicable Cypress software license agreement.

