

REVISIONS				DESCRIPTION	DATE	APPROVED
PAGE	ZONE	REV	ECN			
1	-	**	3482238	CREATED SPEC	01/03/12	ZJL

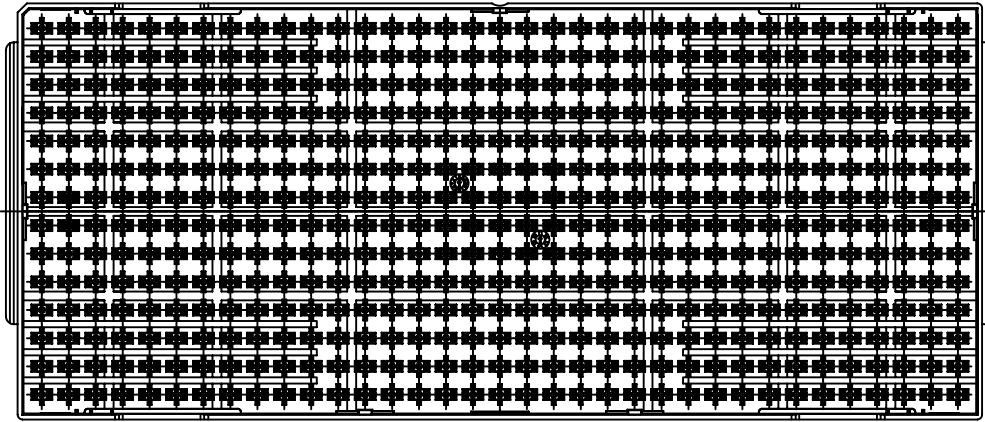

BOTTOM VIEW

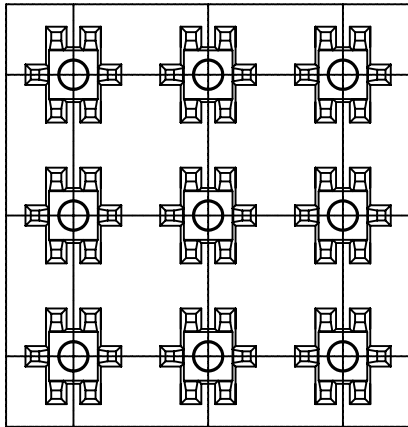

TOP VIEW  
(SCALE:5/1)

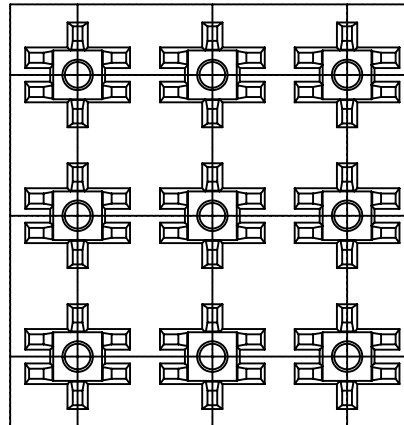

BOTTOM VIEW  
(SCALE:5/1)

THIS DRAWING CONTAINS INFORMATION WHICH IS THE PROPRIETARY PROPERTY OF CYPRESS SEMICONDUCTOR CORPORATION. THIS DRAWING IS RECEIVED IN CONFIDENCE AND ITS CONTENTS MAY NOT BE DISCLOSED WITHOUT WRITTEN CONSENT OF CYPRESS SEMICONDUCTOR CORPORATION.

UNLESS OTHERWISE SPECIFIED ALL DIMENSIONS ARE IN MILLIMETERS STANDARD TOLERANCES ON:  DECIMALS X.X ± 0.25 X.XX ± 0.13 X.XXX ±	DESIGNED BY	DATE
	DRAWN BY	DATE
	CHECKED BY	DATE
	APPROVED BY	DATE
MATERIAL N/A  FINISH N/A	COPI ZJL QJV FJM AZY	01/03/12 01/03/12 01/03/12 01/03/12 01/03/12

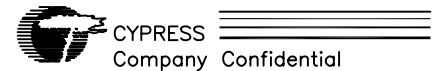

TITLE			
TRAY, 16L QFN 3X3X0.6MM (KOSTAT)			
SIZE	PART NO.	DWG NO	REV
NA	TLF3X3	001-75458	**
SCALED TO FIT	N/A	SHEET 1 OF 3	

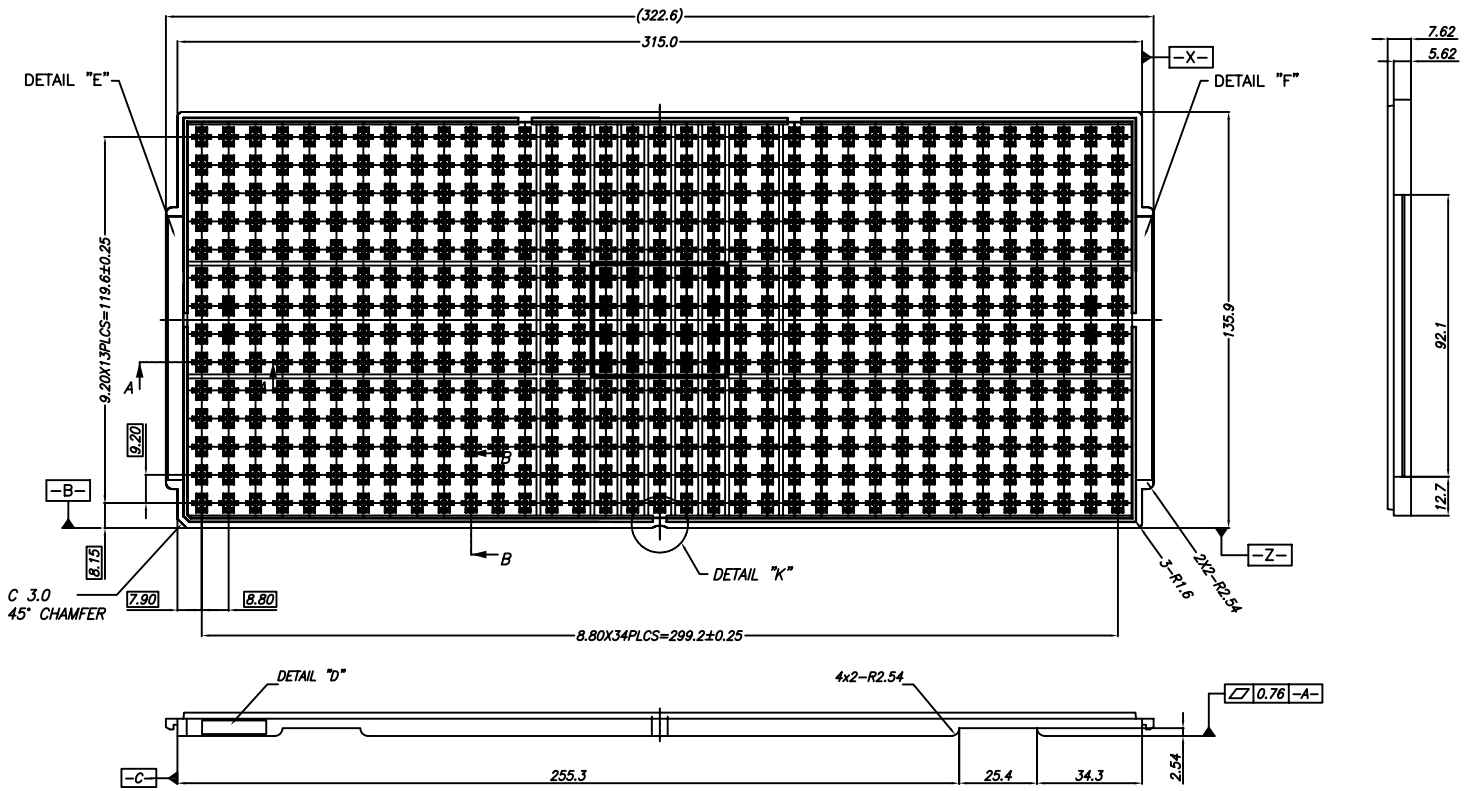

QFN 3.0mmx3.0mm  
 KS-870416 REV.00

DETAIL "D"  
 (SCALE:2/1)



DATE DETAIL  
 (SCALE:2/1)

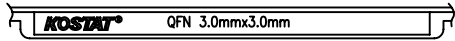

DETAIL "E"  
 (SCALE:2/1)

RECYCLING LOGO MAT'L NAME

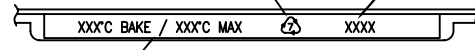

TEMPERATURE RATING BLOCK

DETAIL "F"  
 (SCALE:2/1)



TITLE  
 TRAY, 16L QFN 3X3X0.6MM (KOSTAT)

SIZE NA	PART NO. TLF3X3	DWG NO 001-75458	REV **
SCALED TO FIT		N/A	SHEET 2 OF 3

THIS DRAWING CONTAINS INFORMATION WHICH IS THE PROPRIETARY PROPERTY OF CYPRESS SEMICONDUCTOR CORPORATION. THIS DRAWING IS RECEIVED IN CONFIDENCE AND ITS CONTENTS MAY NOT BE DISCLOSED WITHOUT WRITTEN CONSENT OF CYPRESS SEMICONDUCTOR CORPORATION.

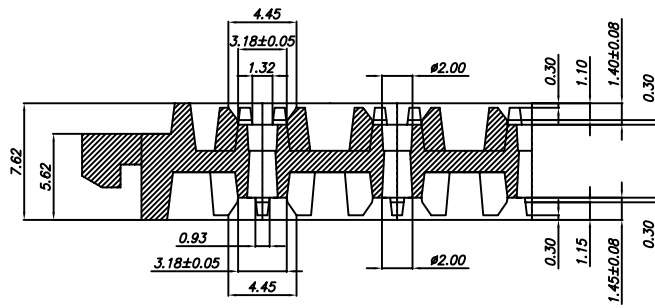

SECTION "A-A"  
(SCALE:5/1)

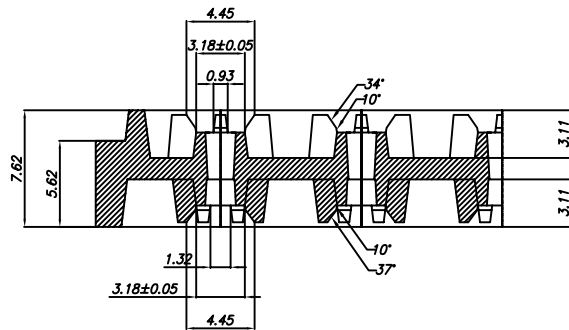

SECTION "B-B"  
(SCALE:5/1)

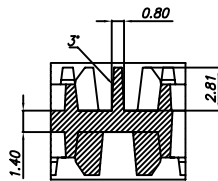

VACUUM CELL  
(SCALE:5/1)

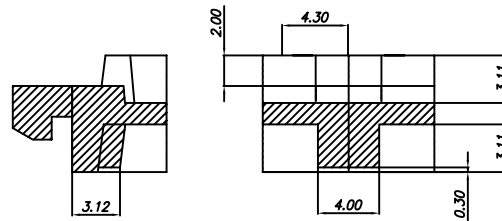

SLIP LOCK DETAIL  
(SCALE:5/1)

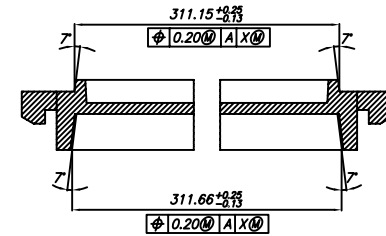

TRAY STACKING DETAIL  
(SCALE:4/1)

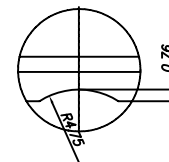
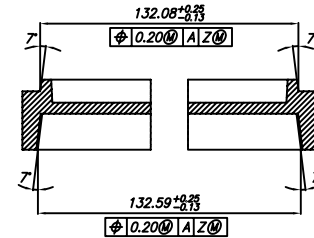

DETAIL "K"  
(SCALE:4/1)

THIS DRAWING CONTAINS INFORMATION WHICH IS THE PROPRIETARY PROPERTY OF CYPRESS SEMICONDUCTOR CORPORATION. THIS DRAWING IS RECEIVED IN CONFIDENCE AND ITS CONTENTS MAY NOT BE DISCLOSED WITHOUT WRITTEN CONSENT OF CYPRESS SEMICONDUCTOR CORPORATION.

CYPRESS  
Company Confidential

TITLE  
TRAY, 16L QFN 3X3X0.6MM (KOSTAT)

SIZE NA	PART NO. TLF3X3	DWG NO 001-75458	REV **
------------	--------------------	---------------------	-----------

SCALED TO FIT	N/A	SHEET 3 OF 3
---------------	-----	--------------